



16-Bit, Ultra-Low Power, Voltage-Output Digital-to-Analog Converters

FEATURES

- 16-Bit Resolution
- 2.7 V to 5.5 V Single-Supply Operation
- Very Low Power: 15 μ W for 3 V Power
- High Accuracy, INL: 1 LSB
- Low Noise: 10 nV/ $\sqrt{\text{Hz}}$
- Fast Settling: 1.0 μ S
- Fast SPI™ Interface, up to 50 MHz
- Reset to Zero-Code
- Schmitt-Trigger Inputs for Direct Optocoupler Interface
- Industry-Standard Pin Configuration

APPLICATIONS

- Portable Equipment
- Automatic Test Equipment
- Industrial Process Control
- Data Acquisition Systems
- Optical Networking

DESCRIPTION

The DAC8830 and DAC8831 are single, 16-bit, serial-input, voltage-output digital-to-analog converters (DACs) operating from a single 3 V to 5 V power supply. These converters provide excellent linearity (1 LSB INL), low glitch, low noise, and fast settling (1.0 μ S to 1/2 LSB of full-scale output) over the specified temperature range of -40°C to $+85^{\circ}\text{C}$. The output is unbuffered, which reduces the power consumption and the error introduced by the buffer.

These parts feature a standard high-speed (clock up to 50 MHz), 3 V or 5 V SPI serial interface to communicate with a DSP or microprocessor.

The DAC8830 output is 0 V to V_{REF} . However, the DAC8831 provides bipolar output ($\pm V_{\text{REF}}$) when working with an external buffer. The DAC8830 and DAC8831 are both reset to zero code after power up. For optimum performance, a set of Kelvin connections to external reference and analog ground input are provided on the DAC8831.

The DAC8830 is available in an SO-8 package, and the DAC8831 in an SO-14 package. Both have industry standard pinouts (see Table 3, the cross-reference table in the Application Information section for details). The DAC8831 is also available in a QFN-14 package.

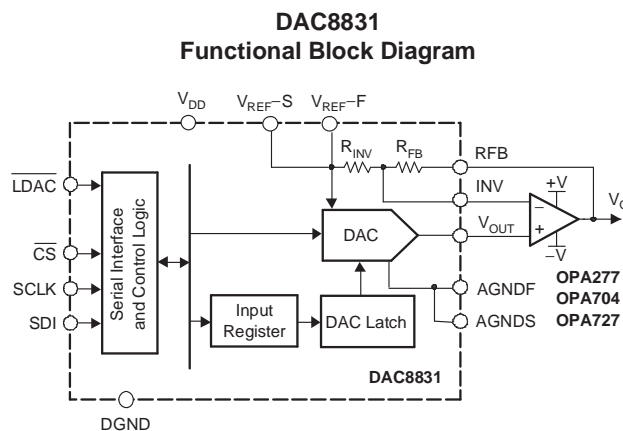
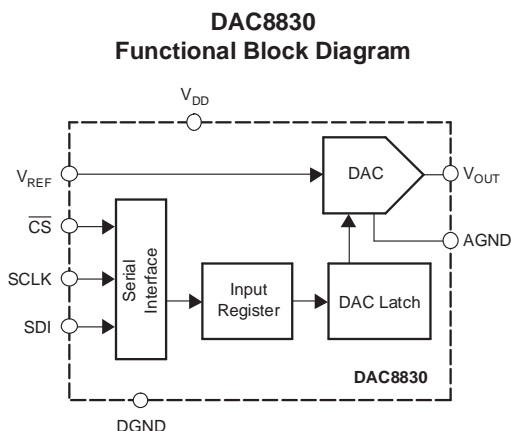

Please be aware that an important notice concerning availability, standard warranty, and use in critical applications of Texas Instruments semiconductor products and disclaimers thereto appears at the end of this data sheet.

SPI, QSPI are trademarks of Motorola, Inc.

Microwire is a trademark of National Semiconductor Corp.

All other trademarks are the property of their respective owners.



This integrated circuit can be damaged by ESD. Texas Instruments recommends that all integrated circuits be handled with appropriate precautions. Failure to observe proper handling and installation procedures can cause damage.

ESD damage can range from subtle performance degradation to complete device failure. Precision integrated circuits may be more susceptible to damage because very small parametric changes could cause the device not to meet its published specifications.

ORDERING INFORMATION⁽¹⁾

PRODUCT	MINIMUM RELATIVE ACCURACY (LSB)	DIFFERENTIAL NONLINEARITY (LSB)	POWER-ON RESET VALUE	SPECIFIED TEMPERATURE RANGE	PACKAGE MARKING	PACKAGE-LEAD	PACKAGE DESIGNATOR	ORDERING NUMBER	TRANSPORT MEDIA, QUANTITY
DAC8830ID	±4	±1	Zero Code	-40°C to +85°C	8830I	SO-8	D	DAC8830ID	Tubes, 75
								DAC8830IDR	Tape and Reel, 2500
DAC8830IBD	±2	±1	Zero Code	-40°C to +85°C	8830I	SO-8	D	DAC8830IBD	Tubes, 75
								DAC8830IBDR	Tape and Reel, 2500
DAC8830ICD	±1	±1	Zero Code	-40°C to +85°C	8830I	SO-8	D	DAC8830ICD	Tubes, 75
								DAC8830ICDR	Tape and Reel, 2500
DAC8831ID	±4	±1	Zero Code	-40°C to +85°C	8831I	SO-14	D	DAC8831ID	Tube, 50
								DAC8831IDR	Tape and Reel, 2500
DAC8831IBD	±2	±1	Zero Code	-40°C to +85°C	8831I	SO-14	D	DAC8831IBD	Tube, 50
								DAC8831IBDR	Tape and Reel, 2500
DAC8831ICD	±1	±1	Zero Code	-40°C to +85°C	8831I	SO-14	D	DAC8831ICD	Tube, 50
								DAC8831ICDR	Tape and Reel, 2500
DAC8831IRGY	±4	±1	Zero Code	-40°C to +85°C	8831I	QFN-14	RGY	DAC8831IRGYT	Tape and Reel, 250
								DAC8831IRGYR	Tape and Reel, 1000
DAC8831IBRGY	±2	±1	Zero Code	-40°C to +85°C	8831I	QFN-14	RGY	DAC8831IBRGYT	Tape and Reel, 250
								DAC8831IBRGYR	Tape and Reel, 1000
DAC8831ICRGY	±1	±1	Zero Code	-40°C to +85°C	8831I	QFN-14	RGY	DAC8831ICRGYT	Tape and Reel, 250
								DAC8831ICRGYR	Tape and Reel, 1000

(1) For the most current package and ordering information, see the Package Option Addendum at the end of this data sheet, or see the TI website at www.ti.com.

ABSOLUTE MAXIMUM RATINGS

Over operating free-air temperature range (unless otherwise noted)⁽¹⁾

	DAC8830, DAC8831	UNIT
V _{DD} to AGND	-0.3 to +7	V
Digital input voltage to DGND	-0.3 to +V _{DD} + 0.3	V
V _{OUT} to AGND	-0.3 to +V _{DD} + 0.3	V
AGND, AGNDF, AGNDS to DGND	-0.3 to +0.3	V
Operating temperature range	-40 to +85	°C
Storage temperature range	-65 to +150	°C
Junction temperature range (T _J max)	+150	°C
Power dissipation	(T _J max - T _A) / θ _{JA}	W
Thermal impedance, θ _{JA}	QFN-14	54.9
	SO-8	136.9
	SO-14	66.6

(1) Stresses above those listed under Absolute Maximum Ratings may cause permanent damage to the device. Exposure to absolute maximum conditions for extended periods may affect device reliability.

ELECTRICAL CHARACTERISTICS

All specifications at $T_A = T_{MIN}$ to T_{MAX} , $V_{DD} = +3\text{ V}$ or $V_{DD} = +5\text{ V}$, $V_{REF} = +2.5\text{ V}$ unless otherwise noted.

PARAMETER		CONDITIONS	DAC8830, DAC8831			UNIT
			MIN	TYP	MAX	
STATIC PERFORMANCE						
Resolution			16			bits
Linearity error	DAC8830ICD, DAC8831ICD, DAC8831ICRGY			±0.5	±1	LSB
	DAC8830IBD, DAC8831IBD, DAC8831IBRGY			±0.5	±2	
	DAC8830ID, DAC8831ID, DAC8831IRGY			±0.5	±4	
Differential linearity error		All grades		±0.5	±1	LSB
Gain error		$T_A = +25^\circ\text{C}$		±1	±5	LSB
		$T_A = -40^\circ\text{C}$ to $+85^\circ\text{C}$			±7	
Gain drift				±0.1		ppm/°C
Zero code error		$T_A = +25^\circ\text{C}$		±0.25	±1	LSB
		$T_A = -40^\circ\text{C}$ to $+85^\circ\text{C}$			±2	
Zero code drift				±0.05		ppm/°C
OUTPUT CHARACTERISTICS						
Voltage output ⁽¹⁾	All devices	Unipolar operation		0	$+V_{REF}$	V
	DAC8831 only	Bipolar operation		$-V_{REF}$	$+V_{REF}$	V
Output impedance				6.25		kΩ
Settling time		To 1/2 LSB of FS, $C_L = 10\text{ pF}$		1		μs
Slew rate ⁽²⁾		$C_L = 10\text{ pF}$		25		V/μs
Digital-to-analog glitch		1 LSB change around major carry		35		nV-s
Digital feedthrough ⁽³⁾				0.2		nV-s
Output noise	DAC8830	$T_A = +25^\circ\text{C}$		10		nV/√Hz
	DAC8831			18		
Power-supply rejection		V_{DD} varies ±10%			±1	LSB
Bipolar resistor matching	DAC8831 only	R_{FB} / R_{INV}		1		Ω/Ω
		Ratio error		±0.0015	±0.0076	%
Bipolar zero error	DAC8831 only	$T_A = +25^\circ\text{C}$		±0.25	±5	LSB
		$T_A = -40^\circ\text{C}$ to $+85^\circ\text{C}$			±7	
Bipolar zero drift		DAC8831 only		±0.2		ppm/°C

(1) The DAC8830 output is unipolar (0 V to $+V_{REF}$). The DAC8831 output is bipolar ($\pm V_{REF}$) when it connects to an external buffer (see the [Bipolar Output Operation](#) section for details).

(2) Slew rate is measured from 10% to 90% of transition when the output changes from 0 to full-scale.

(3) Digital feedthrough is defined as the impulse injected into the analog output from the digital input. It is measured when the DAC output does not change; \overline{CS} is held high, while SCLK and DIN signals are toggled.

ELECTRICAL CHARACTERISTICS (continued)

All specifications at $T_A = T_{MIN}$ to T_{MAX} , $V_{DD} = +3\text{ V}$ or $V_{DD} = +5\text{ V}$, $V_{REF} = +2.5\text{ V}$ unless otherwise noted.

PARAMETER	CONDITIONS	DAC8830, DAC8831			UNIT
		MIN	TYP	MAX	
REFERENCE INPUT					
Reference input voltage range		1.25		V_{DD}	V
Reference input impedance ⁽⁴⁾	Unipolar mode	9			k Ω
	Bipolar mode, DAC8831	7.5			
Reference -3dB bandwidth, BW	Code = FFFFh		1.3		MHz
Reference feedthrough	Code = 0000h, $V_{REF} = 1\text{ V}_{PP}$ at 100 kHz		1		mV
Signal-to-noise ratio, SNR			92		dB
Reference input capacitance	Code = 0000h		75		pF
	Code = FFFFh		120		
DIGITAL INPUTS					
V_{IL} Input low voltage	$V_{DD} = 2.7\text{ V}$			0.6	V
	$V_{DD} = 5\text{ V}$			0.8	
V_{IH} Input high voltage	$V_{DD} = 2.7\text{ V}$	2.1			V
	$V_{DD} = 5\text{ V}$	2.4			
Input current				± 1	μA
Input capacitance				10	pF
Hysteresis voltage			0.4		V
POWER SUPPLY					
V_{DD} Power-supply voltage		2.7		5.5	V
I_{DD} Power-supply current	$V_{DD} = 3\text{ V}$		5	20	μA
	$V_{DD} = 5\text{ V}$		5	20	
Power	$V_{DD} = 3\text{ V}$		15	60	μW
	$V_{DD} = 5\text{ V}$		25	100	
TEMPERATURE RANGE					
Specified performance		-40		+85	$^{\circ}\text{C}$

(4) Reference input resistance is code-dependent, minimum at 8555h.

PIN CONFIGURATIONS (NOT TO SCALE)

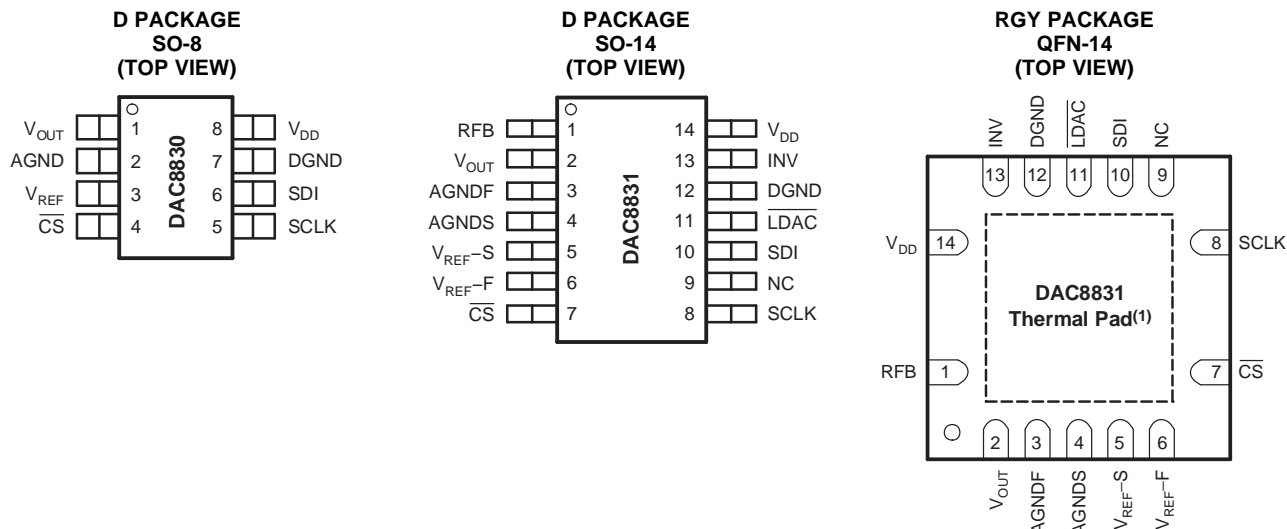

NOTE: (1) Exposed thermal pad in the QFN package must be connected to analog ground.

TERMINAL FUNCTIONS

TERMINAL NO.	NAME	DESCRIPTION
DAC8830		
1	V_{OUT}	Analog output of DAC
2	AGND	Analog ground
3	V_{REF}	Voltage reference input
4	\overline{CS}	Chip select input (active low). Data are not clocked into SDI unless \overline{CS} is low
5	SCLK	Serial clock input
6	SDI	Serial data input. Data are latched into input register on the rising edge of SCLK.
7	DGND	Digital ground
8	V_{DD}	Analog power supply, +3 V to +5 V
DAC8831		
1	RFB	Feedback resistor. Connect to the output of external operational amplifier in bipolar mode.
2	V_{OUT}	Analog output of DAC
3	AGNDF	Analog ground (Force)
4	AGNDS	Analog ground (Sense)
5	V_{REF-S}	Voltage reference input (Sense). Connect to external voltage reference
6	V_{REF-F}	Voltage reference input (Force). Connect to external voltage reference
7	\overline{CS}	Chip select input (active low). Data are not clocked into SDI unless \overline{CS} is low.
8	SCLK	Serial clock input.
9	NC	No internal connection
10	SDI	Serial data input. Data are latched into input register on the rising edge of SCLK.
11	\overline{LDAC}	Load DAC control input. Active low. When \overline{LDAC} is Low, the DAC latch is simultaneously updated with the content of the input register.
12	DGND	Digital ground
13	INV	Junction point of internal scaling resistors. Connect to external operational amplifier inverting input in bipolar mode.
14	V_{DD}	Analog power supply, +3 V to +5 V.

TIMING CHARACTERISTICS: $V_{DD} = +5 V^{(1)(2)}$

 At $-40^{\circ}C$ to $+85^{\circ}C$, unless otherwise noted.

PARAMETER		MIN	MAX	UNIT
t_{sck}	SCLK period	20		ns
t_{wsck}	SCLK high or low time	10		ns
t_{Delay}	Delay from SCLK high to \overline{CS} low	10		ns
t_{Lead}	\overline{CS} enable lead time	10		ns
t_{Lag}	\overline{CS} enable lag time	10		ns
t_{DSCLK}	Delay from \overline{CS} high to SCLK high	10		ns
t_{td}	\overline{CS} high between active period	30		ns
t_{su}	Data setup time (input)	10		ns
t_{ho}	Data hold time (input)	0		ns
t_{WLDAC}	\overline{LDAC} width	30		ns
t_{DLDAC}	Delay from \overline{CS} high to \overline{LDAC} low	30		ns
	V_{DD} high to \overline{CS} low (power-up delay)	10		μs

(1) Assured by design. Not production tested.

(2) Sample tested during the initial release and after any redesign or process changes that may affect this parameter.

TIMING CHARACTERISTICS: $V_{DD} = +3 V^{(1)(2)}$

 At $-40^{\circ}C$ to $+85^{\circ}C$, unless otherwise noted.

PARAMETER		MIN	MAX	UNIT
t_{sck}	SCLK period	20		ns
t_{wsck}	SCLK high or low time	10		ns
t_{Delay}	Delay from SCLK high to \overline{CS} low	10		ns
t_{Lead}	\overline{CS} enable lead time	10		ns
t_{Lag}	\overline{CS} enable lag time	10		ns
t_{DSCLK}	Delay from \overline{CS} high to SCLK high	10		ns
t_{td}	\overline{CS} high between active period	30		ns
t_{su}	Data setup time (input)	10		ns
t_{ho}	Data hold time (input)	0		ns
t_{WLDAC}	\overline{LDAC} width	30		ns
t_{DLDAC}	Delay from \overline{CS} high to \overline{LDAC} low	30		ns
	V_{DD} high to \overline{CS} low (power-up delay)	10		μs

(1) Assured by design. Not production tested.

(2) Sample tested during the initial release and after any redesign or process changes that may affect this parameter.

TYPICAL CHARACTERISTICS: $V_{DD} = +5\text{ V}$
At $T_A = +25^\circ\text{C}$ and $V_{REF} = +2.5\text{ V}$, unless otherwise noted.

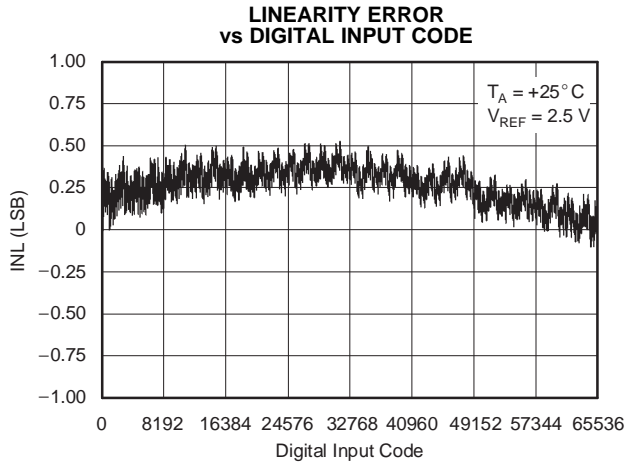

Figure 3.

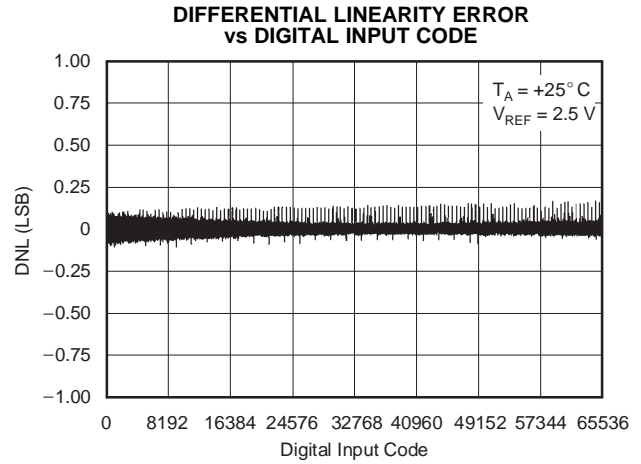

Figure 4.

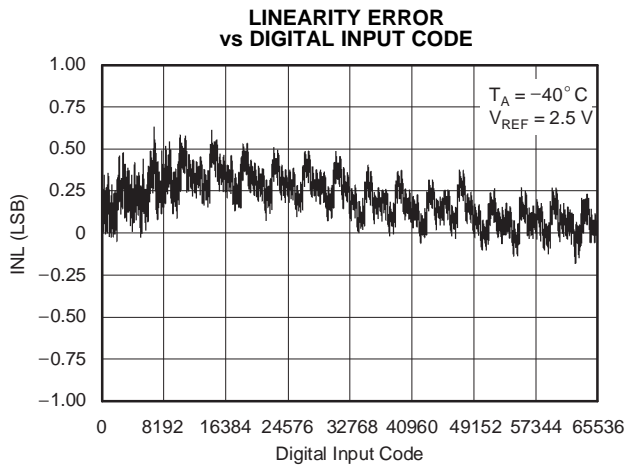

Figure 5.

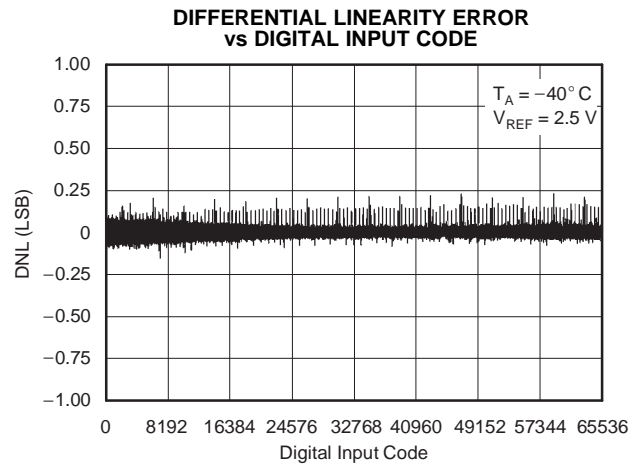

Figure 6.

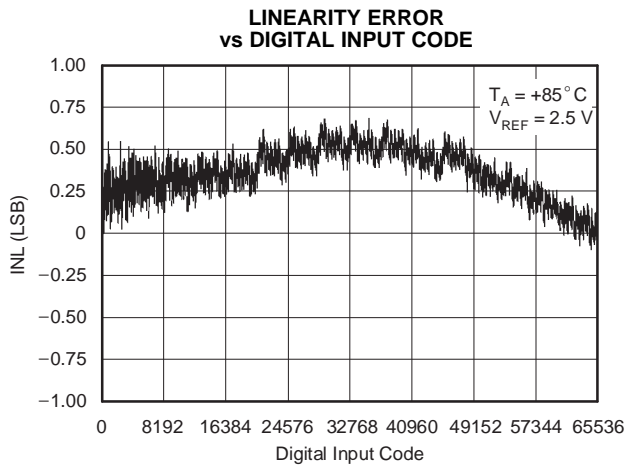

Figure 7.

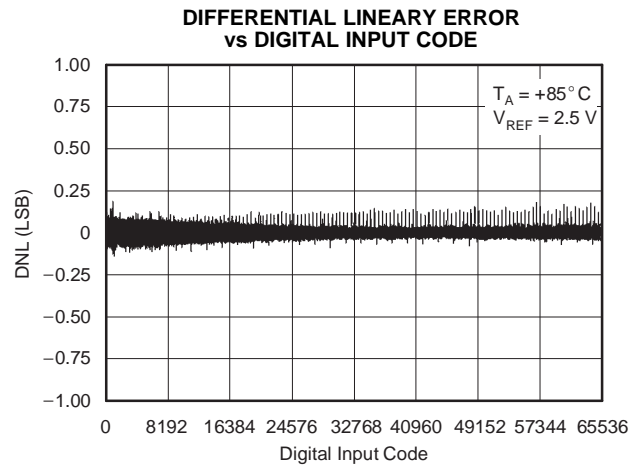

Figure 8.

TYPICAL CHARACTERISTICS: $V_{DD} = +5\text{ V}$ (continued)

At $T_A = +25^\circ\text{C}$ and $V_{REF} = +2.5\text{ V}$, unless otherwise noted.

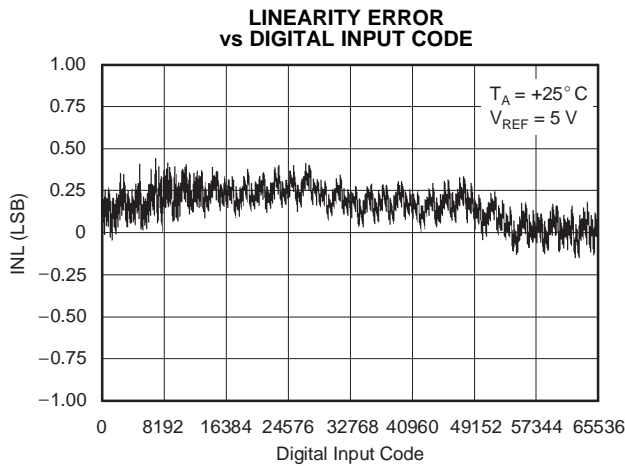

Figure 9.

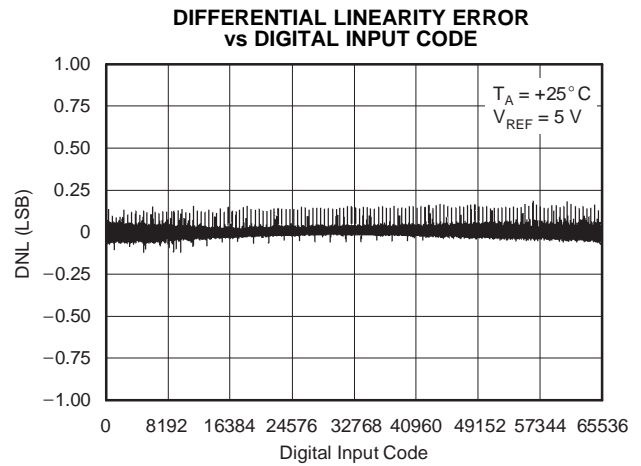

Figure 10.

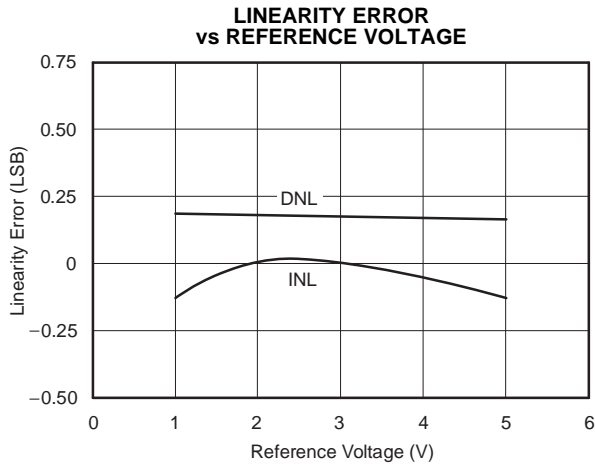

Figure 11.

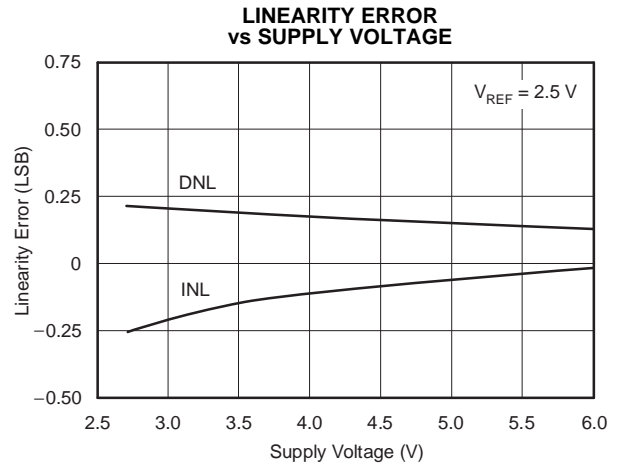

Figure 12.

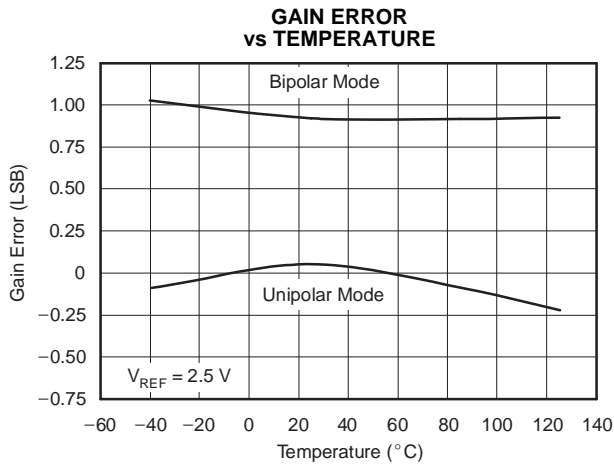

Figure 13.

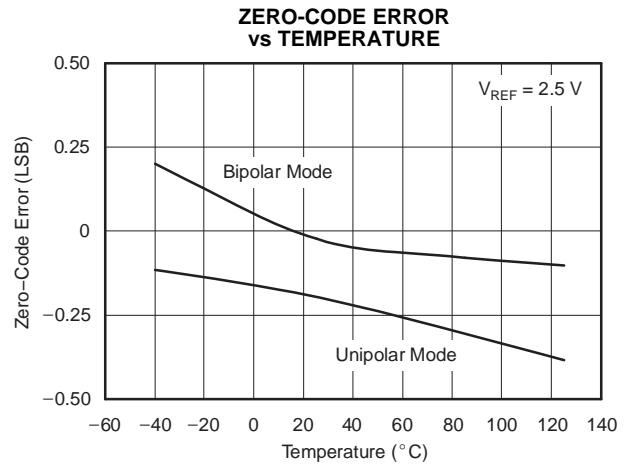

Figure 14.

TYPICAL CHARACTERISTICS: $V_{DD} = +5\text{ V}$ (continued)

At $T_A = +25^\circ\text{C}$ and $V_{REF} = +2.5\text{ V}$, unless otherwise noted.

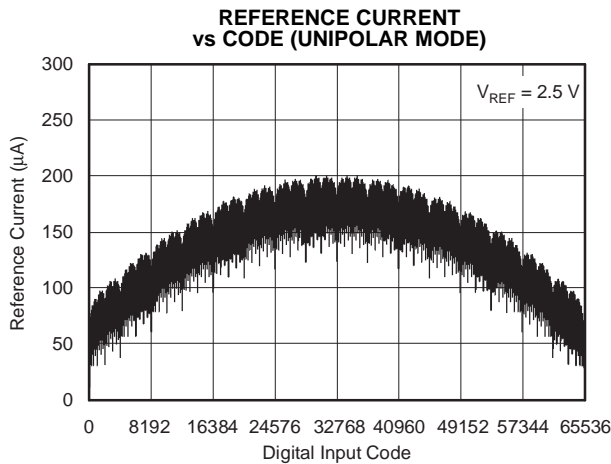

Figure 15.

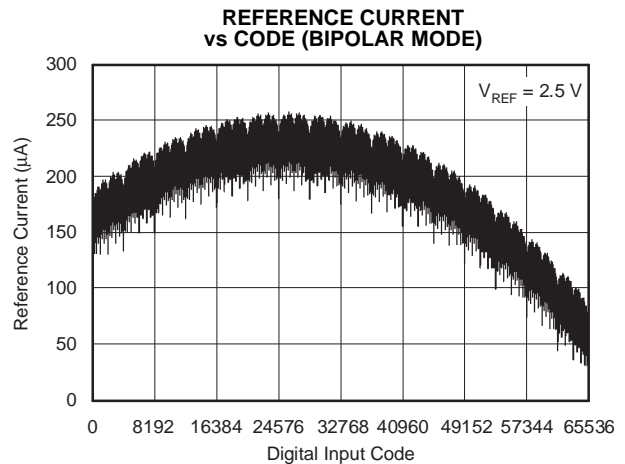

Figure 16.

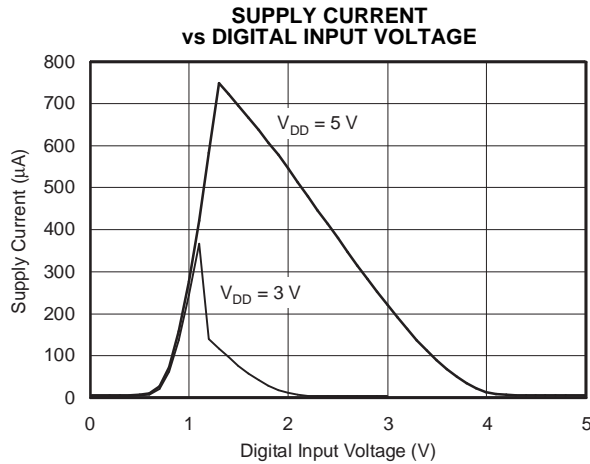

Figure 17.

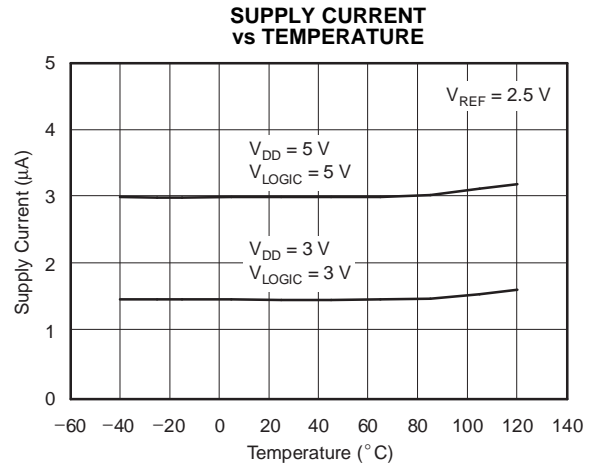

Figure 18.

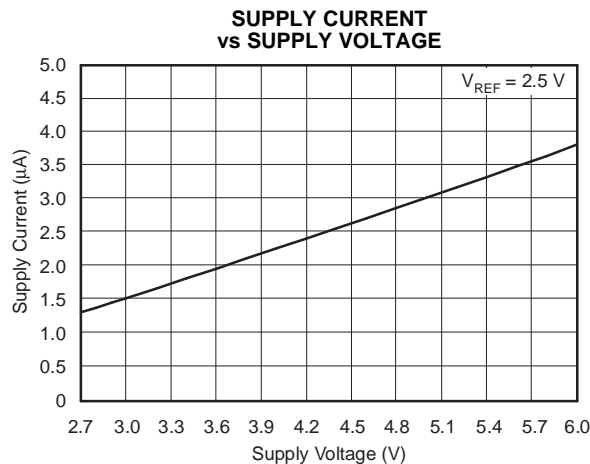

Figure 19.

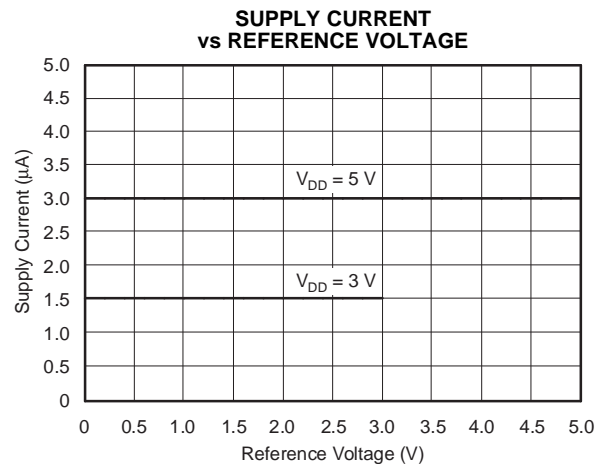

Figure 20.

TYPICAL CHARACTERISTICS: $V_{DD} = +5\text{ V}$ (continued)

At $T_A = +25^\circ\text{C}$ and $V_{REF} = +2.5\text{ V}$, unless otherwise noted.

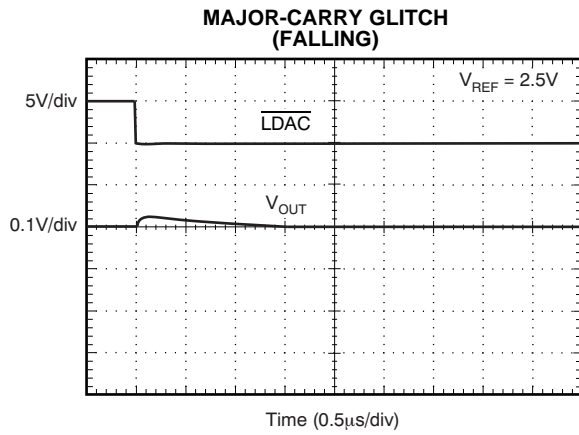

Figure 21.

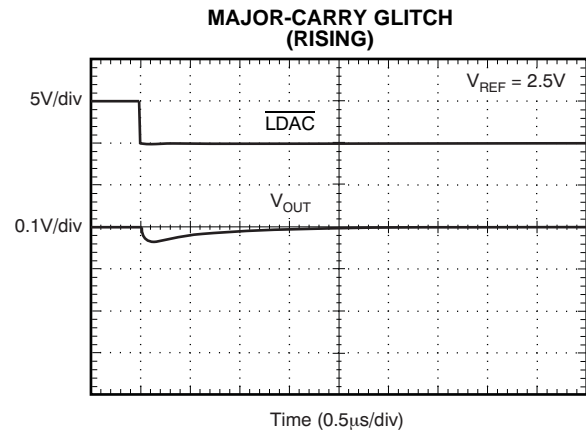

Figure 22.

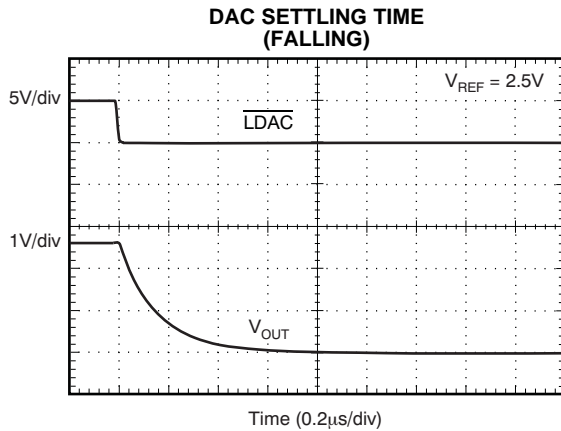

Figure 23.

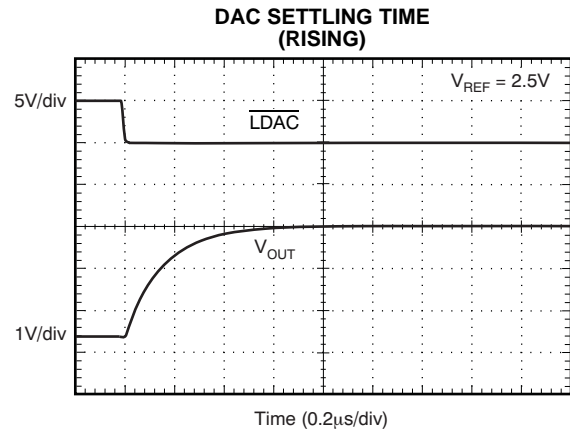

Figure 24.

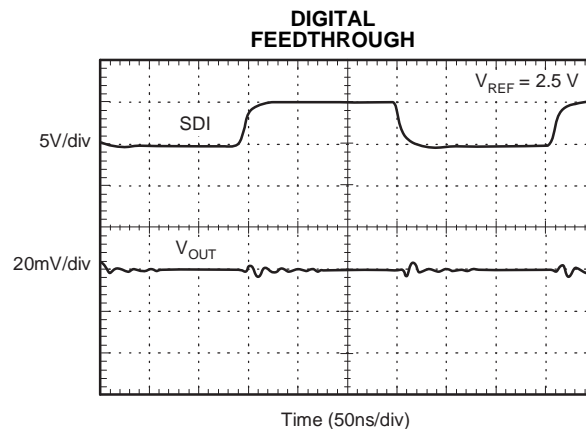

Figure 25.

TYPICAL CHARACTERISTICS: $V_{DD} = +3\text{ V}$

At $T_A = +25^\circ\text{C}$ and $V_{REF} = +2.5\text{ V}$, unless otherwise noted.

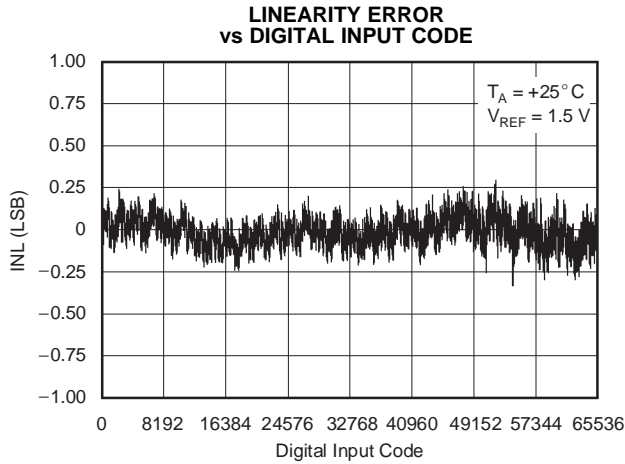

Figure 26.

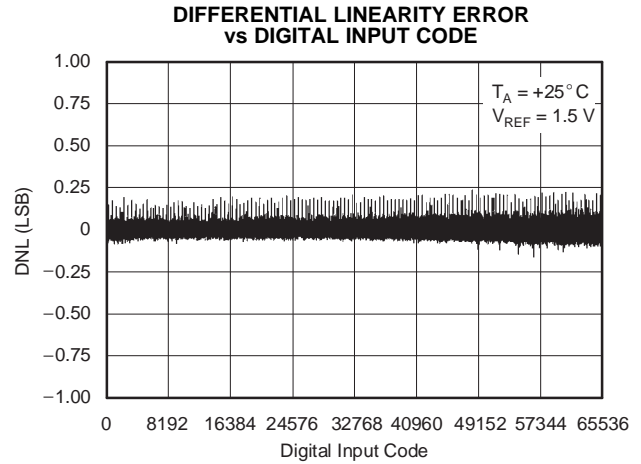

Figure 27.

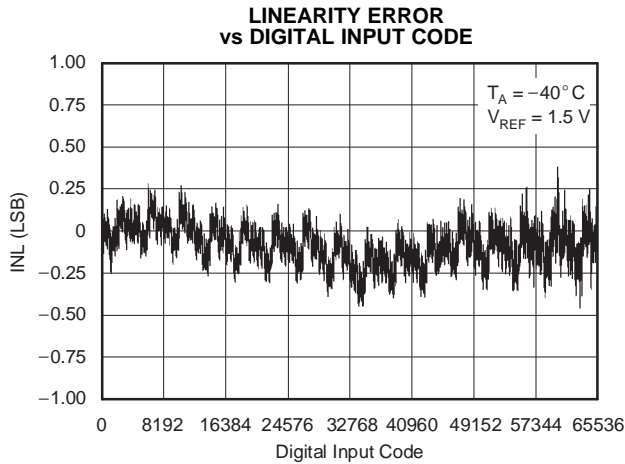

Figure 28.

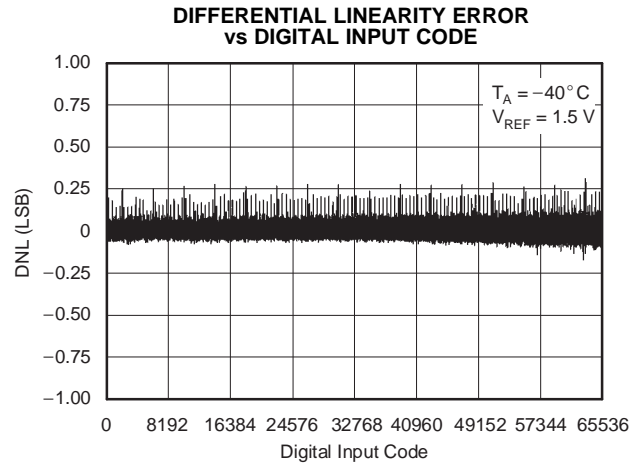

Figure 29.

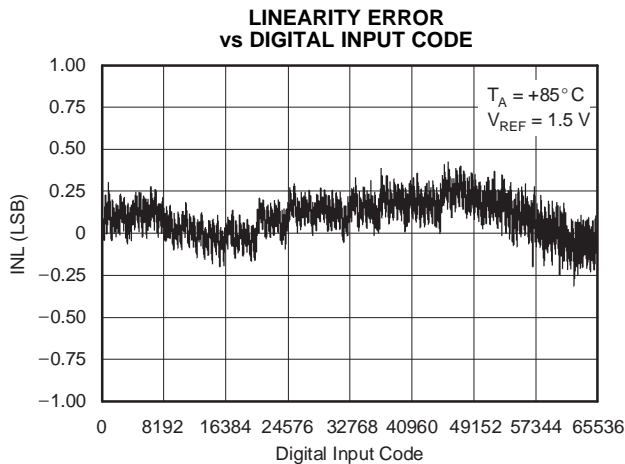

Figure 30.

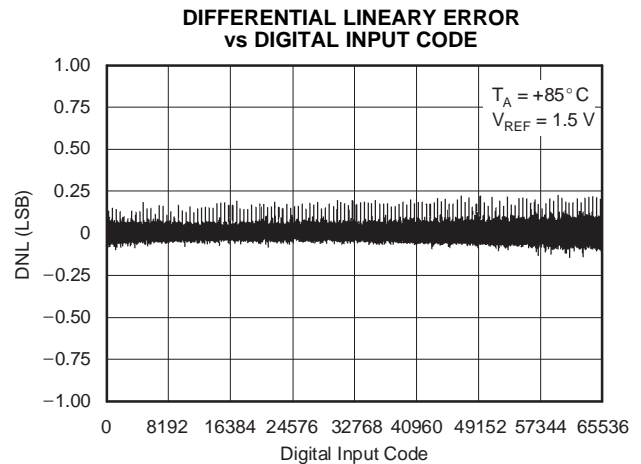

Figure 31.

TYPICAL CHARACTERISTICS: $V_{DD} = +3\text{ V}$ (continued)

At $T_A = +25^\circ\text{C}$ and $V_{REF} = +2.5\text{ V}$, unless otherwise noted.

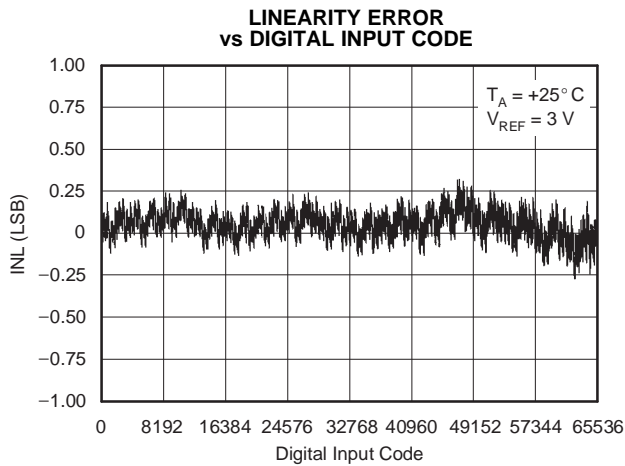

Figure 32.

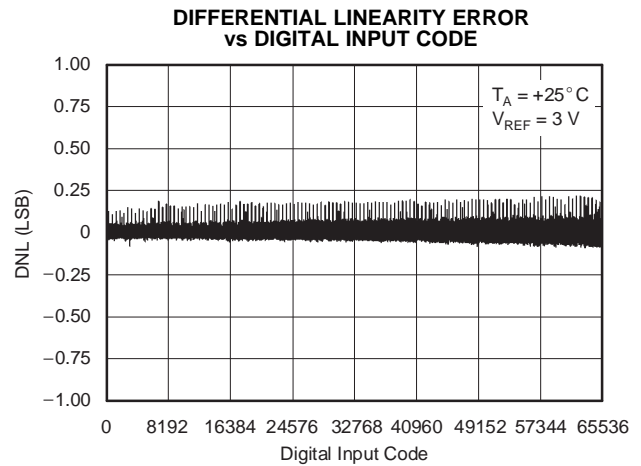

Figure 33.

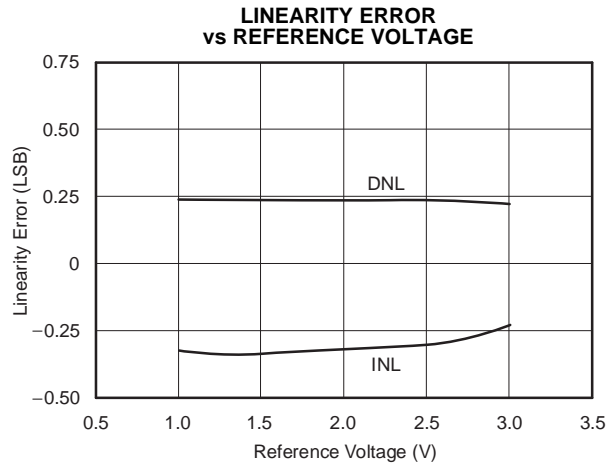

Figure 34.

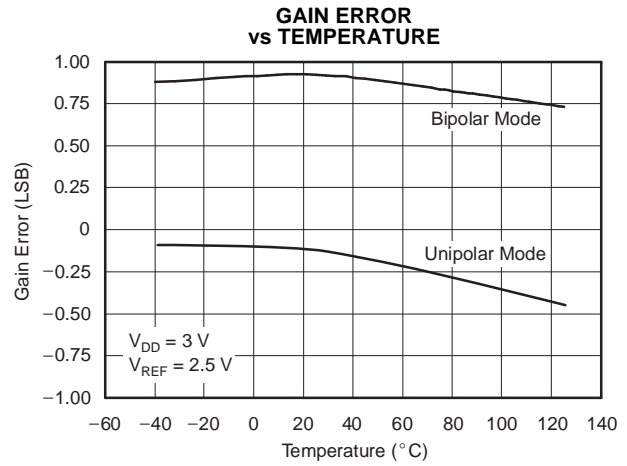

Figure 35.

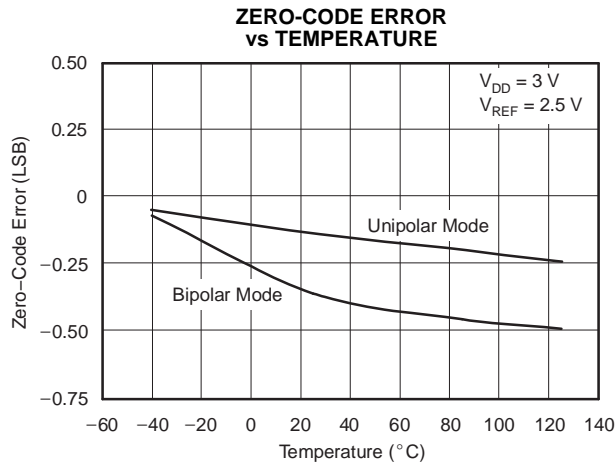

Figure 36.

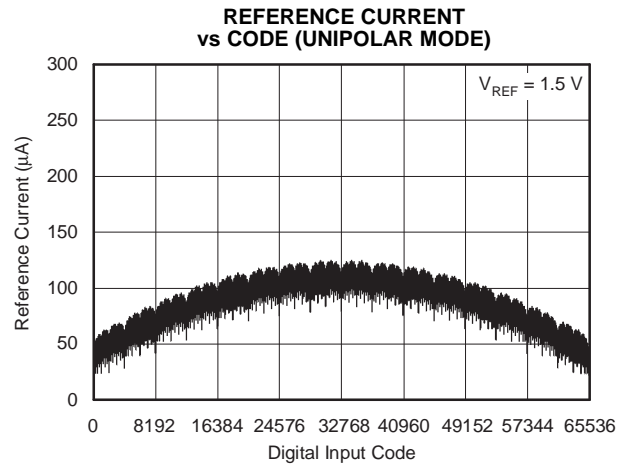

Figure 37.

TYPICAL CHARACTERISTICS: $V_{DD} = +3\text{ V}$ (continued)

At $T_A = +25^\circ\text{C}$ and $V_{REF} = +2.5\text{ V}$, unless otherwise noted.

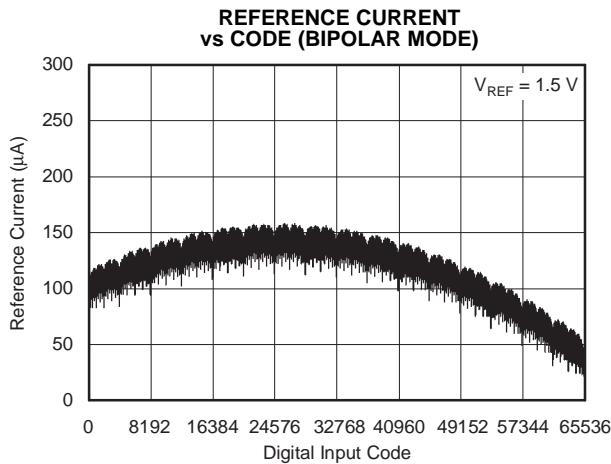

Figure 38.

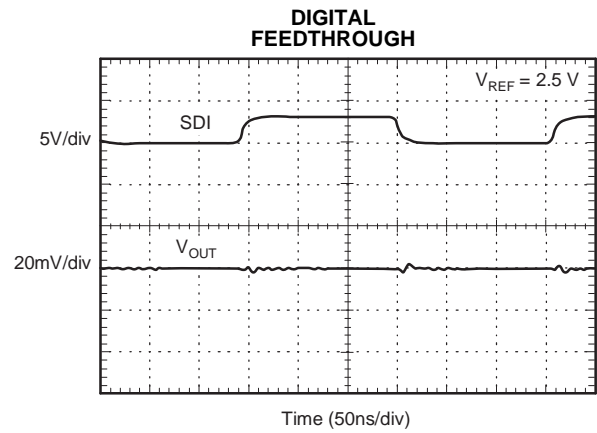

Figure 39.

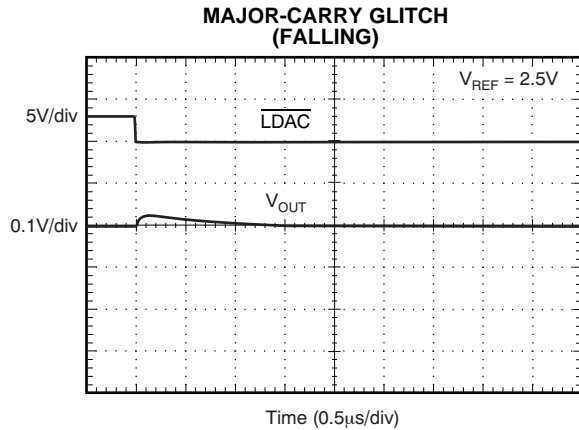

Figure 40.

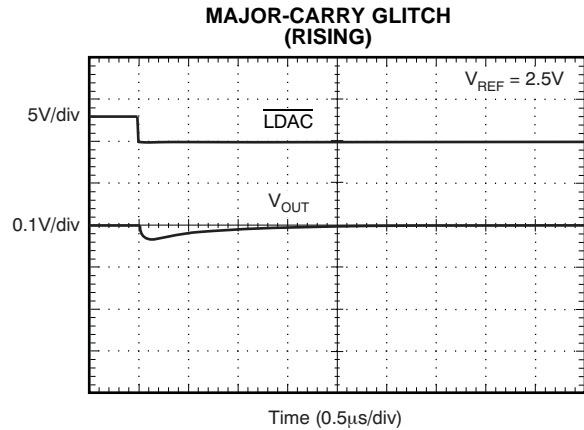

Figure 41.

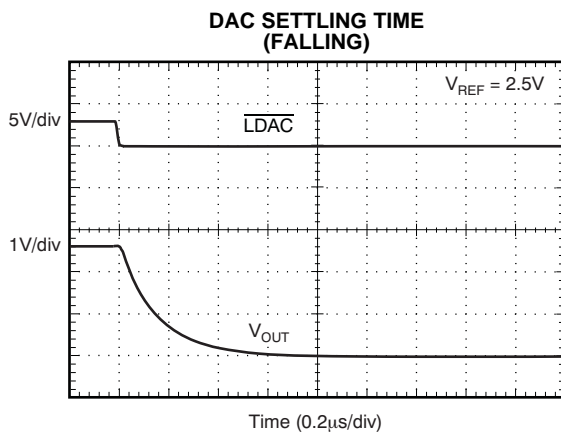

Figure 42.



Figure 43.

THEORY OF OPERATION

GENERAL DESCRIPTION

The DAC8830 and DAC8831 are single, 16-bit, serial-input, voltage-output DACs. They operate from a single

supply ranging from 2.7 V to 5 V, and typically consume 5 μ A. Data are written to these devices in a 16-bit word format, via an SPI serial interface. To ensure a known power-up state, these parts are designed with a power-on reset function. The DAC8830 and DAC8831 are reset to zero code. In unipolar mode, the DAC8830 and DAC8831 are reset to 0 V, and in bipolar mode, the DAC8831 is reset to $-V_{REF}$. Kelvin sense connections for the reference and analog ground are included on the DAC8831.

DIGITAL-TO-ANALOG SECTIONS

The DAC architecture for both devices consists of two matched DAC sections and is segmented. A simplified circuit diagram is shown in Figure 44. The four MSBs of the 16-bit data word are decoded to drive 15 switches, E1 to E15. Each of these switches connects one of 15 matched resistors to either AGND or V_{REF} . The remaining 12 bits of the data word drive switches S0 to S11 of a 12-bit voltage mode R-2R ladder network.

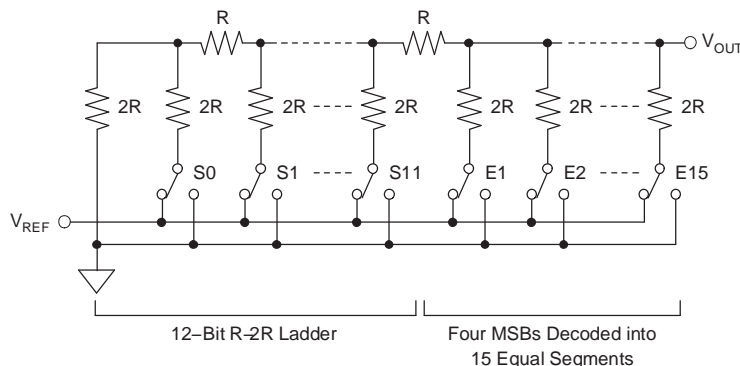

Figure 44. DAC Architecture

OUTPUT RANGE

The output of the DAC is

$$V_{OUT} = (V_{REF} \times Code)/65536.$$

Where *Code* is the decimal data word loaded to the DAC latch.

POWER-ON RESET

Both devices have a power-on reset function to ensure the output is at a known state upon power-up. In the DAC8830 and DAC8831, at power-up, the DAC latch and Input Registers contain all 0s until new data are loaded from the input serial shift register. Therefore, after power-up, the output from pin V_{OUT} of the DAC8830 is 0 V. The output from pin V_{OUT} of the DAC8831 is 0 V in unipolar mode and $-V_{REF}$ in bipolar mode.

However, the serial register of the DAC8830 and DAC8831 is not cleared on power-up, so its contents are undefined. When loading data initially to the device, 16 bits or more should be loaded to prevent erroneous data appearing on the output. If more than 16 bits are loaded, the last 16 are kept; if less than 16 are loaded, bits will remain from the previous word. If the device must be interfaced with data shorter than 16 bits, the data should be padded with 0s at the LSBs.

Serial Interface

The digital interface is a standard 3-wire connection compatible with SPI, QSPI™, Microwire™, and TI DSP interfaces, which can operate at speeds up to 50 M-bits/sec. The data transfer is framed by \overline{CS} , the chip select signal. The DAC works as a bus slave. The bus master generates the synchronize clock, SCLK, and initiates the transmission. When \overline{CS} is high, the DAC is not accessed, and the clock SCLK and serial input data SDI are ignored. The bus master accesses the DAC by driving pin \overline{CS} low. Immediately following the high-to-low transition of \overline{CS} , the serial input data on pin SDI is shifted out from the bus master synchronously on the falling edge of SCLK, and latched on the rising edge of SCLK into the input shift register, MSB first. The low-to-high transition of \overline{CS} transfers the contents of the input shift register to the input register. All data registers are 16-bit. It takes 16 clocks of SCLK to transfer one data word to the parts. To complete a whole data word, \overline{CS} must go high immediately after 16 SCLKs are clocked in. If more than 16 SCLKs are applied during the low state of \overline{CS} , the last 16 bits are transferred to the input register on the rising edge of \overline{CS} . However, if \overline{CS} is not kept low during the entire 16 SCLK cycles, data is corrupted. In this case, reload the DAC with a new 16-bit word.

In the DAC8830, the contents of the input register are transferred into the DAC latch immediately when the input register is loaded, and the DAC output is updated at the same time.

The DAC8831 has an \overline{LDAC} pin allowing the DAC latch to be updated asynchronously by bringing \overline{LDAC} low after \overline{CS} goes high. In this case, \overline{LDAC} must be maintained high while \overline{CS} is low. If \overline{LDAC} is tied permanently low, the DAC latch is updated immediately after the input register is loaded (caused by the low-to-high transition of \overline{CS}).

APPLICATION INFORMATION

Unipolar Output Operation

These DACs are capable of driving unbuffered loads of 60 kΩ. Unbuffered operation results in low supply current (typically 5 μA) and a low offset error. The DAC8830 provides a unipolar output swing ranging from 0 V to V_{REF} . The DAC8831 can be configured to output both unipolar and bipolar voltages. Figure 45 and Figure 46 show a typical unipolar output voltage circuit for each device, respectively. The code table for this mode of operation is shown in Table 1.

Table 1. Unipolar Code

DAC LATCH CONTENTS		ANALOG OUTPUT
MSB	LSB	
1111	1111 1111 1111	$V_{REF} \times (65,535/65,536)$
1000	0000 0000 0000	$V_{REF} \times (32,768/65,536) = 1/2 V_{REF}$
0000	0000 0000 0001	$V_{REF} \times (1/65,536)$
0000	0000 0000 0000	0 V

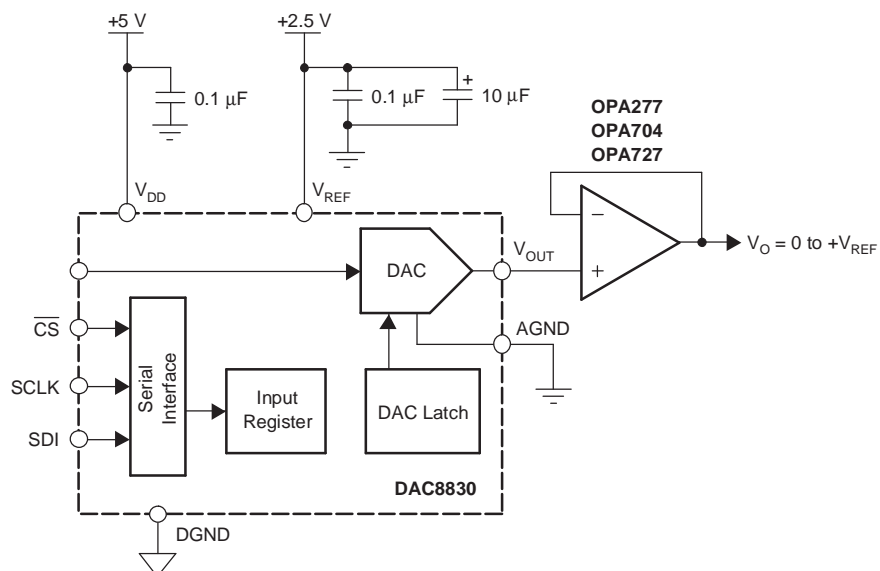

Figure 45. Unipolar Output Mode of DAC8830

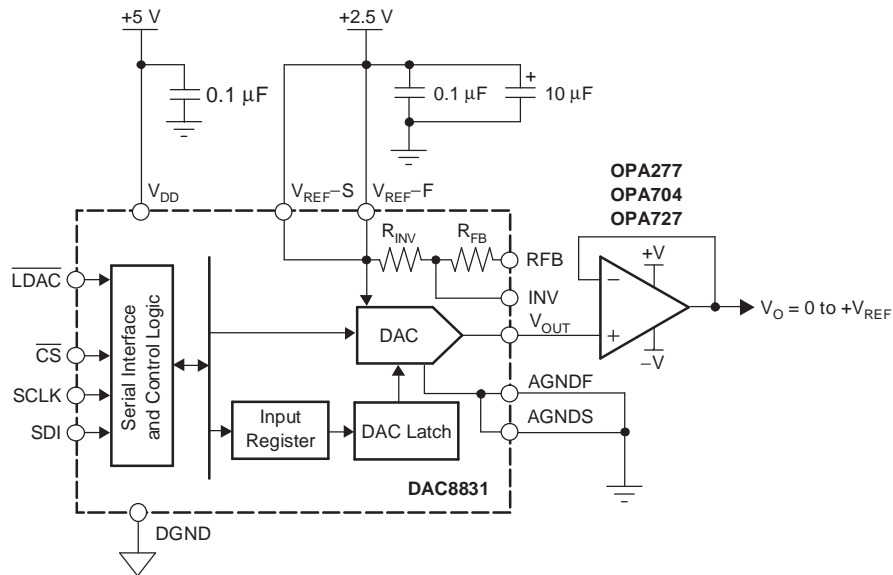

Figure 46. Unipolar Output Mode of DAC8831

Assuming a perfect reference, the worst-case output voltage may be calculated from the following equation:

Unipolar Mode Worst-Case Output

$$V_{\text{OUT_UNI}} = \frac{D}{2^{16}} \times (V_{\text{REF}} + V_{\text{GE}}) + V_{\text{ZSE}} + \text{INL}$$

Where:

$V_{\text{OUT_UNI}}$ = Unipolar mode worst-case output

D = Code loaded to DAC

V_{REF} = Reference voltage applied to part

V_{GE} = Gain error in volts

V_{ZSE} = Zero-scale error in volts

INL = Integral nonlinearity in volts

Bipolar Output Operation

With the aid of an external operational amplifier, the DAC8831 may be configured to provide a bipolar voltage output. A typical circuit of such an operation is shown in Figure 47. The matched bipolar offset resistors R_{FB} and R_{INV} are connected to an external operational amplifier to achieve this bipolar output swing; typically, $R_{FB} = R_{INV} = 28\text{ k}\Omega$.

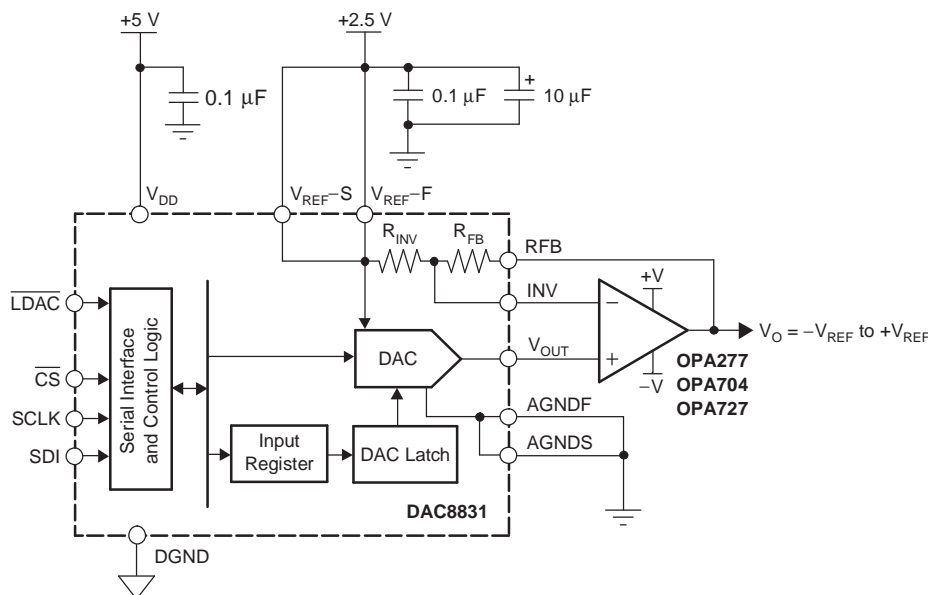

Figure 47. Bipolar Output Mode of DAC8831

Table 2 shows the transfer function for this output operating mode. The DAC8831 also provides a set of Kelvin connections to the analog ground and external reference inputs.

Table 2. Bipolar Code

DAC LATCH CONTENTS		ANALOG OUTPUT
MSB	LSB	
1111 1111 1111 1111		$+V_{REF} \times (32,767/32,768)$
1000 0000 0000 0001		$+V_{REF} \times (1/32,768)$
1000 0000 0000 0000		0 V
0111 1111 1111 1111		$-V_{REF} \times (1/32,768)$
0000 0000 0000 0000		$-V_{REF} \times (32,768/32,768) = -V_{REF}$

Assuming a perfect reference, the worst-case output voltage may be calculated from the following equation:

Bipolar Mode Worst-Case Output

$$V_{OUT_BIP} = \frac{\left[(V_{OUT_UNI} + V_{OS}) (2 + RD) - V_{REF}(1 + RD) \right]}{1 + \left(\frac{2 + RD}{A} \right)}$$

Where:

V_{OS} = External operational amplifier input offset voltage

$RD = R_{FB}$ and R_{IN} resistor matching error

A = Operational amplifier open-loop gain

Output Amplifier Selection

For bipolar mode, a precision amplifier should be used, supplied from a dual power supply. This provides the $\pm V_{REF}$ output.

In a single-supply application, selection of a suitable operational amplifier may be more difficult because the output swing of the amplifier does not usually include the negative rail; in this case, AGND. This output swing can result in some degradation of the specified performance unless the application does not use codes near 0.

The selected operational amplifier needs to have low-offset voltage (the DAC LSB is 38 μ V with a 2.5 V reference), eliminating the need for output offset trims. Input bias current should also be low because the bias current multiplied by the DAC output impedance (approximately 6.25 k Ω) adds to the zero-code error.

Rail-to-rail input and output performance are required. For fast settling, the slew rate of the operational amplifier should not impede the settling time of the DAC. Output impedance of the DAC is constant and code-independent, but in order to minimize gain errors the input impedance of the output amplifier should be as high as possible. The amplifier should also have a 3 dB bandwidth of 1 MHz or greater. The amplifier adds another time constant to the system, thus increasing the settling time of the output. A higher 3 dB amplifier bandwidth results in a shorter effective settling time of the combined DAC and amplifier.

Reference and Ground

Since the input impedance is code-dependent, the reference pin should be driven from a low impedance source. The DAC8830 and DAC8831 operate with a voltage reference ranging from 1.25 V to V_{DD} . References below 1.25 V result in reduced accuracy.

The DAC full-scale output voltage is determined by the reference. [Table 1](#) and [Table 2](#) outline the analog output voltage for particular digital codes.

For optimum performance, Kelvin sense connections are provided on the DAC8831. If the application does not require separate force and sense lines, they should be tied together close to the package to minimize voltage drops between the package leads and the internal die.

Power Supply and Reference Bypassing

For accurate high-resolution performance, it is recommended that the reference and supply pins be bypassed with a 10 μ F tantalum capacitor in parallel with a 0.1 μ F ceramic capacitor.

CROSS-REFERENCE

The DAC8830 and DAC8831 have an industry-standard pinout configuration (see [Table 3](#)).

Table 3. Cross-Reference

MODEL	INL (LSB)	DNL (LSB)	POWER-ON RESET TO	TEMPERATURE RANGE	PACKAGE DESCRIPTION	PACKAGE OPTION	CROSS REFERENCE
DAC8830ICD	±1	±1	Zero Code	–40°C to +85°C	8-Lead Small Outline IC	SO-8	AD5541CR, MAX541AESA
DAC8830IBD	±2	±1	Zero Code	–40°C to +85°C	8-Lead Small Outline IC	SO-8	AD5541BR, MAX541BESA
DAC8830ID	±4	±1	Zero Code	–40°C to +85°C	8-Lead Small Outline IC	SO-8	AD5541AR, MAX541CESA
N/A	±1	±1	Zero Code	–40°C to +85°C	8-Lead Plastic DIP	PDIP-8	MAX541AEP A
N/A	±2	±1	Zero Code	–40°C to +85°C	8-Lead Plastic DIP	PDIP-8	MAX541BEP A
N/A	±4	±1	Zero Code	–40°C to +85°C	8-Lead Plastic DIP	PDIP-8	MAX541CEP A
N/A	±1	±1	Zero Code	0°C to +70°C	8-Lead Small Outline IC	SO-8	AD5541LR
N/A	±2	±1.5	Zero Code	0°C to +70°C	8-Lead Small Outline IC	SO-8	AD5541JR
N/A	±1	±1	Zero Code	0°C to +70°C	8-Lead Plastic DIP	PDIP-8	MAX541AEP A
N/A	±2	±1	Zero Code	0°C to +70°C	8-Lead Plastic DIP	PDIP-8	MAX541BEP A
N/A	±4	±1	Zero Code	0°C to +70°C	8-Lead Plastic DIP	PDIP-8	MAX541CEP A
DAC8831ICD	±1	±1	Zero Code	–40°C to +85°C	14-Lead Small Outline IC	SO-14	AD5542CR, MAX542AESA
DAC8831IBD	±2	±1	Zero Code	–40°C to +85°C	14-Lead Small Outline IC	SO-14	AD5542BR, MAX542BESA
DAC8831ID	±4	±1	Zero Code	–40°C to +85°C	14-Lead Small Outline IC	SO-14	AD5542AR, MAX542CESA
DAC8831ICRGY	±1	±1	Zero Code	–40°C to +85°C	14-Lead QFN	QFN-14	N/A
DAC8831IBRGY	±2	±1	Zero Code	–40°C to +85°C	14-Lead QFN	QFN-14	N/A
DAC8831IRGY	±4	±1	Zero Code	–40°C to +85°C	14-Lead QFN	QFN-14	N/A
N/A	±1	±1	Zero Code	–40°C to +85°C	14-Lead Plastic DIP	PDIP-14	MAX542ACPD
N/A	±2	±1	Zero Code	–40°C to +85°C	14-Lead Plastic DIP	PDIP-14	MAX542BCPD
N/A	±4	±1	Zero Code	–40°C to +85°C	14-Lead Plastic DIP	PDIP-14	MAX542CCPD
N/A	±1	±1	Zero Code	0°C to +70°C	14-Lead Small Outline IC	SO-14	AD5542LR
N/A	±2	±1.5	Zero Code	0°C to +70°C	14-Lead Small Outline IC	SO-14	AD5542JR
N/A	±1	±1	Zero Code	0°C to +70°C	14-Lead Small Outline IC	SO-14	MAX542AEPD
N/A	±2	±1	Zero Code	0°C to +70°C	14-Lead Small Outline IC	SO-14	MAX542BEPD
N/A	±4	±1	Zero Code	0°C to +70°C	14-Lead Small Outline IC	SO-14	MAX542CEPD

PACKAGING INFORMATION

Orderable Device	Status (1)	Package Type	Package Drawing	Pins	Package Qty	Eco Plan (2)	Lead/Ball Finish (6)	MSL Peak Temp (3)	Op Temp (°C)	Device Marking (4/5)	Samples
DAC8830IBD	ACTIVE	SOIC	D	8	75	Green (RoHS & no Sb/Br)	CU NIPDAU	Level-2-260C-1 YEAR	-40 to 85	DAC 8830I	Samples
DAC8830IBDG4	ACTIVE	SOIC	D	8	75	Green (RoHS & no Sb/Br)	CU NIPDAU	Level-2-260C-1 YEAR	-40 to 85	DAC 8830I	Samples
DAC8830IBDR	ACTIVE	SOIC	D	8	2500	Green (RoHS & no Sb/Br)	CU NIPDAU	Level-2-260C-1 YEAR	-40 to 85	DAC 8830I	Samples
DAC8830IBDRG4	ACTIVE	SOIC	D	8	2500	Green (RoHS & no Sb/Br)	CU NIPDAU	Level-2-260C-1 YEAR	-40 to 85	DAC 8830I	Samples
DAC8830ICD	ACTIVE	SOIC	D	8	75	Green (RoHS & no Sb/Br)	CU NIPDAU	Level-2-260C-1 YEAR	-40 to 85	DAC 8830I	Samples
DAC8830ICDG4	ACTIVE	SOIC	D	8	75	Green (RoHS & no Sb/Br)	CU NIPDAU	Level-2-260C-1 YEAR	-40 to 85	DAC 8830I	Samples
DAC8830ICDR	ACTIVE	SOIC	D	8	2500	Green (RoHS & no Sb/Br)	CU NIPDAU	Level-2-260C-1 YEAR	-40 to 85	DAC 8830I	Samples
DAC8830ICDRG4	ACTIVE	SOIC	D	8	2500	Green (RoHS & no Sb/Br)	CU NIPDAU	Level-2-260C-1 YEAR	-40 to 85	DAC 8830I	Samples
DAC8830ID	ACTIVE	SOIC	D	8	75	Green (RoHS & no Sb/Br)	CU NIPDAU	Level-2-260C-1 YEAR	-40 to 85	DAC 8830I	Samples
DAC8830IDG4	ACTIVE	SOIC	D	8	75	Green (RoHS & no Sb/Br)	CU NIPDAU	Level-2-260C-1 YEAR	-40 to 85	DAC 8830I	Samples
DAC8830IDR	ACTIVE	SOIC	D	8	2500	Green (RoHS & no Sb/Br)	CU NIPDAU	Level-2-260C-1 YEAR	-40 to 85	DAC 8830I	Samples
DAC8830IDRG4	ACTIVE	SOIC	D	8	2500	Green (RoHS & no Sb/Br)	CU NIPDAU	Level-2-260C-1 YEAR	-40 to 85	DAC 8830I	Samples
DAC8831IBD	ACTIVE	SOIC	D	14	50	Green (RoHS & no Sb/Br)	CU NIPDAU	Level-2-260C-1 YEAR	-40 to 85	DAC8831I	Samples
DAC8831IBDG4	ACTIVE	SOIC	D	14	50	Green (RoHS & no Sb/Br)	CU NIPDAU	Level-2-260C-1 YEAR	-40 to 85	DAC8831I	Samples
DAC8831IBDR	ACTIVE	SOIC	D	14	2500	Green (RoHS & no Sb/Br)	CU NIPDAU	Level-2-260C-1 YEAR	-40 to 85	DAC8831I	Samples
DAC8831IBDRG4	ACTIVE	SOIC	D	14	2500	Green (RoHS & no Sb/Br)	CU NIPDAU	Level-2-260C-1 YEAR	-40 to 85	DAC8831I	Samples
DAC8831IBRGYT	ACTIVE	VQFN	RGY	14	250	Green (RoHS & no Sb/Br)	CU NIPDAU	Level-2-260C-1 YEAR	-40 to 85	BKE	Samples

Orderable Device	Status (1)	Package Type	Package Drawing	Pins	Package Qty	Eco Plan (2)	Lead/Ball Finish (6)	MSL Peak Temp (3)	Op Temp (°C)	Device Marking (4/5)	Samples
DAC8831IBRGYTG4	ACTIVE	VQFN	RGY	14	250	Green (RoHS & no Sb/Br)	CU NIPDAU	Level-2-260C-1 YEAR	-40 to 85	BKE	Samples
DAC8831ICD	ACTIVE	SOIC	D	14	50	Green (RoHS & no Sb/Br)	CU NIPDAU	Level-2-260C-1 YEAR	-40 to 85	DAC8831I	Samples
DAC8831ICDG4	ACTIVE	SOIC	D	14	50	Green (RoHS & no Sb/Br)	CU NIPDAU	Level-2-260C-1 YEAR	-40 to 85	DAC8831I	Samples
DAC8831ICDR	ACTIVE	SOIC	D	14	2500	Green (RoHS & no Sb/Br)	CU NIPDAU	Level-2-260C-1 YEAR	-40 to 85	DAC8831I	Samples
DAC8831ICDRG4	ACTIVE	SOIC	D	14	2500	Green (RoHS & no Sb/Br)	CU NIPDAU	Level-2-260C-1 YEAR	-40 to 85	DAC8831I	Samples
DAC8831ICRGYT	ACTIVE	VQFN	RGY	14	250	Green (RoHS & no Sb/Br)	CU NIPDAU	Level-2-260C-1 YEAR	-40 to 85	BKE	Samples
DAC8831ICRGYTG4	ACTIVE	VQFN	RGY	14	250	Green (RoHS & no Sb/Br)	CU NIPDAU	Level-2-260C-1 YEAR	-40 to 85	BKE	Samples
DAC8831ID	ACTIVE	SOIC	D	14	50	Green (RoHS & no Sb/Br)	CU NIPDAU	Level-2-260C-1 YEAR	-40 to 85	DAC8831I	Samples
DAC8831IDG4	ACTIVE	SOIC	D	14	50	Green (RoHS & no Sb/Br)	CU NIPDAU	Level-2-260C-1 YEAR	-40 to 85	DAC8831I	Samples
DAC8831IDR	ACTIVE	SOIC	D	14	2500	Green (RoHS & no Sb/Br)	CU NIPDAU	Level-2-260C-1 YEAR	-40 to 85	DAC8831I	Samples
DAC8831IDRG4	ACTIVE	SOIC	D	14	2500	Green (RoHS & no Sb/Br)	CU NIPDAU	Level-2-260C-1 YEAR	-40 to 85	DAC8831I	Samples
DAC8831IRGYT	ACTIVE	VQFN	RGY	14	250	Green (RoHS & no Sb/Br)	CU NIPDAU	Level-2-260C-1 YEAR	-40 to 85	BKE	Samples
DAC8831IRGYTG4	ACTIVE	VQFN	RGY	14	250	Green (RoHS & no Sb/Br)	CU NIPDAU	Level-2-260C-1 YEAR	-40 to 85	BKE	Samples

(1) The marketing status values are defined as follows:

ACTIVE: Product device recommended for new designs.

LIFEBUY: TI has announced that the device will be discontinued, and a lifetime-buy period is in effect.

NRND: Not recommended for new designs. Device is in production to support existing customers, but TI does not recommend using this part in a new design.

PREVIEW: Device has been announced but is not in production. Samples may or may not be available.

OBSOLETE: TI has discontinued the production of the device.

(2) Eco Plan - The planned eco-friendly classification: Pb-Free (RoHS), Pb-Free (RoHS Exempt), or Green (RoHS & no Sb/Br) - please check <http://www.ti.com/productcontent> for the latest availability information and additional product content details.

TBD: The Pb-Free/Green conversion plan has not been defined.

Pb-Free (RoHS): TI's terms "Lead-Free" or "Pb-Free" mean semiconductor products that are compatible with the current RoHS requirements for all 6 substances, including the requirement that lead not exceed 0.1% by weight in homogeneous materials. Where designed to be soldered at high temperatures, TI Pb-Free products are suitable for use in specified lead-free processes.

Pb-Free (RoHS Exempt): This component has a RoHS exemption for either 1) lead-based flip-chip solder bumps used between the die and package, or 2) lead-based die adhesive used between the die and leadframe. The component is otherwise considered Pb-Free (RoHS compatible) as defined above.

Green (RoHS & no Sb/Br): TI defines "Green" to mean Pb-Free (RoHS compatible), and free of Bromine (Br) and Antimony (Sb) based flame retardants (Br or Sb do not exceed 0.1% by weight in homogeneous material)

⁽³⁾ MSL, Peak Temp. - The Moisture Sensitivity Level rating according to the JEDEC industry standard classifications, and peak solder temperature.

⁽⁴⁾ There may be additional marking, which relates to the logo, the lot trace code information, or the environmental category on the device.

⁽⁵⁾ Multiple Device Markings will be inside parentheses. Only one Device Marking contained in parentheses and separated by a "~" will appear on a device. If a line is indented then it is a continuation of the previous line and the two combined represent the entire Device Marking for that device.

⁽⁶⁾ Lead/Ball Finish - Orderable Devices may have multiple material finish options. Finish options are separated by a vertical ruled line. Lead/Ball Finish values may wrap to two lines if the finish value exceeds the maximum column width.

Important Information and Disclaimer:The information provided on this page represents TI's knowledge and belief as of the date that it is provided. TI bases its knowledge and belief on information provided by third parties, and makes no representation or warranty as to the accuracy of such information. Efforts are underway to better integrate information from third parties. TI has taken and continues to take reasonable steps to provide representative and accurate information but may not have conducted destructive testing or chemical analysis on incoming materials and chemicals. TI and TI suppliers consider certain information to be proprietary, and thus CAS numbers and other limited information may not be available for release.

In no event shall TI's liability arising out of such information exceed the total purchase price of the TI part(s) at issue in this document sold by TI to Customer on an annual basis.

OTHER QUALIFIED VERSIONS OF DAC8830, DAC8831 :

- Enhanced Product: [DAC8830-EP](#), [DAC8831-EP](#)

NOTE: Qualified Version Definitions:

- Enhanced Product - Supports Defense, Aerospace and Medical Applications

TAPE AND REEL INFORMATION

QUADRANT ASSIGNMENTS FOR PIN 1 ORIENTATION IN TAPE

*All dimensions are nominal

Device	Package Type	Package Drawing	Pins	SPQ	Reel Diameter (mm)	Reel Width W1 (mm)	A0 (mm)	B0 (mm)	K0 (mm)	P1 (mm)	W (mm)	Pin1 Quadrant
DAC8830IBDR	SOIC	D	8	2500	330.0	12.4	6.4	5.2	2.1	8.0	12.0	Q1
DAC8830ICDR	SOIC	D	8	2500	330.0	12.4	6.4	5.2	2.1	8.0	12.0	Q1
DAC8830IDR	SOIC	D	8	2500	330.0	12.4	6.4	5.2	2.1	8.0	12.0	Q1
DAC8831IBDR	SOIC	D	14	2500	330.0	16.4	6.5	9.0	2.1	8.0	16.0	Q1
DAC8831IBRGYT	VQFN	RGY	14	250	180.0	12.4	3.85	3.85	1.35	8.0	12.0	Q1
DAC8831ICDR	SOIC	D	14	2500	330.0	16.4	6.5	9.0	2.1	8.0	16.0	Q1
DAC8831ICRGYT	VQFN	RGY	14	250	180.0	12.4	3.85	3.85	1.35	8.0	12.0	Q1
DAC8831IDR	SOIC	D	14	2500	330.0	16.4	6.5	9.0	2.1	8.0	16.0	Q1
DAC8831IRGYT	VQFN	RGY	14	250	180.0	12.4	3.85	3.85	1.35	8.0	12.0	Q1

TAPE AND REEL BOX DIMENSIONS

*All dimensions are nominal

Device	Package Type	Package Drawing	Pins	SPQ	Length (mm)	Width (mm)	Height (mm)
DAC8830IBDR	SOIC	D	8	2500	367.0	367.0	35.0
DAC8830ICDR	SOIC	D	8	2500	367.0	367.0	35.0
DAC8830IDR	SOIC	D	8	2500	367.0	367.0	35.0
DAC8831IBDR	SOIC	D	14	2500	367.0	367.0	38.0
DAC8831IBRGYT	VQFN	RGY	14	250	210.0	185.0	35.0
DAC8831ICDR	SOIC	D	14	2500	367.0	367.0	38.0
DAC8831ICRGYT	VQFN	RGY	14	250	210.0	185.0	35.0
DAC8831IDR	SOIC	D	14	2500	367.0	367.0	38.0
DAC8831IRGYT	VQFN	RGY	14	250	210.0	185.0	35.0

D (R-PDSO-G14)

PLASTIC SMALL OUTLINE



- NOTES:
- All linear dimensions are in millimeters.
 - This drawing is subject to change without notice.
 - Publication IPC-7351 is recommended for alternate designs.
 - Laser cutting apertures with trapezoidal walls and also rounding corners will offer better paste release. Customers should contact their board assembly site for stencil design recommendations. Refer to IPC-7525 for other stencil recommendations.
 - Customers should contact their board fabrication site for solder mask tolerances between and around signal pads.

RGY (S-PVQFN-N14)

PLASTIC QUAD FLATPACK NO-LEAD



- NOTES:
- A. All linear dimensions are in millimeters. Dimensioning and tolerancing per ASME Y14.5M-1994.
 - B. This drawing is subject to change without notice.
 - C. QFN (Quad Flatpack No-Lead) package configuration.
 - D. The package thermal pad must be soldered to the board for thermal and mechanical performance.
 - E. See the additional figure in the Product Data Sheet for details regarding the exposed thermal pad features and dimensions.
 - F. Pin 1 identifiers are located on both top and bottom of the package and within the zone indicated. The Pin 1 identifiers are either a molded, marked, or metal feature.
 - G. Package complies to JEDEC MO-241 variation BA.

RGY (S-PVQFN-N14)

PLASTIC QUAD FLATPACK NO-LEAD

THERMAL INFORMATION

This package incorporates an exposed thermal pad that is designed to be attached directly to an external heatsink. The thermal pad must be soldered directly to the printed circuit board (PCB). After soldering, the PCB can be used as a heatsink. In addition, through the use of thermal vias, the thermal pad can be attached directly to the appropriate copper plane shown in the electrical schematic for the device, or alternatively, can be attached to a special heatsink structure designed into the PCB. This design optimizes the heat transfer from the integrated circuit (IC).

For information on the Quad Flatpack No-Lead (QFN) package and its advantages, refer to Application Report, QFN/SON PCB Attachment, Texas Instruments Literature No. SLUA271. This document is available at www.ti.com.

The exposed thermal pad dimensions for this package are shown in the following illustration.

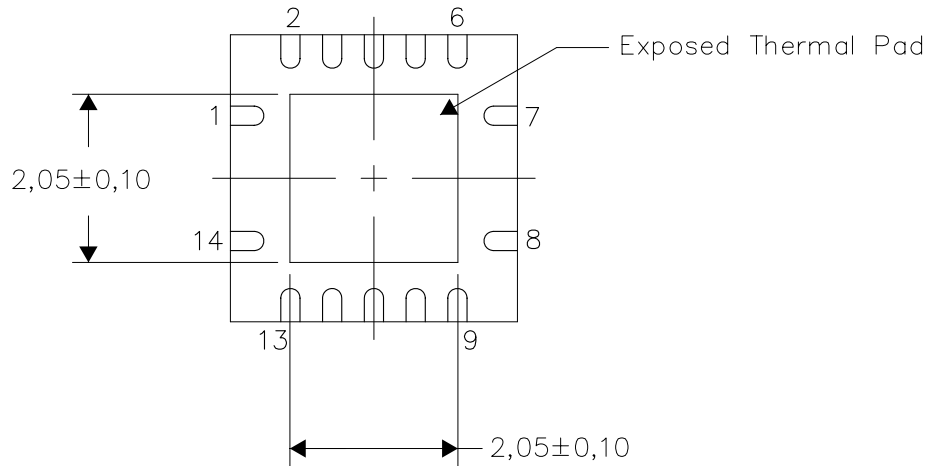

Bottom View

Exposed Thermal Pad Dimensions

4206353-2/0 11/11

NOTE: All linear dimensions are in millimeters

RGY (S-PVQFN-N14)

PLASTIC QUAD FLATPACK NO-LEAD

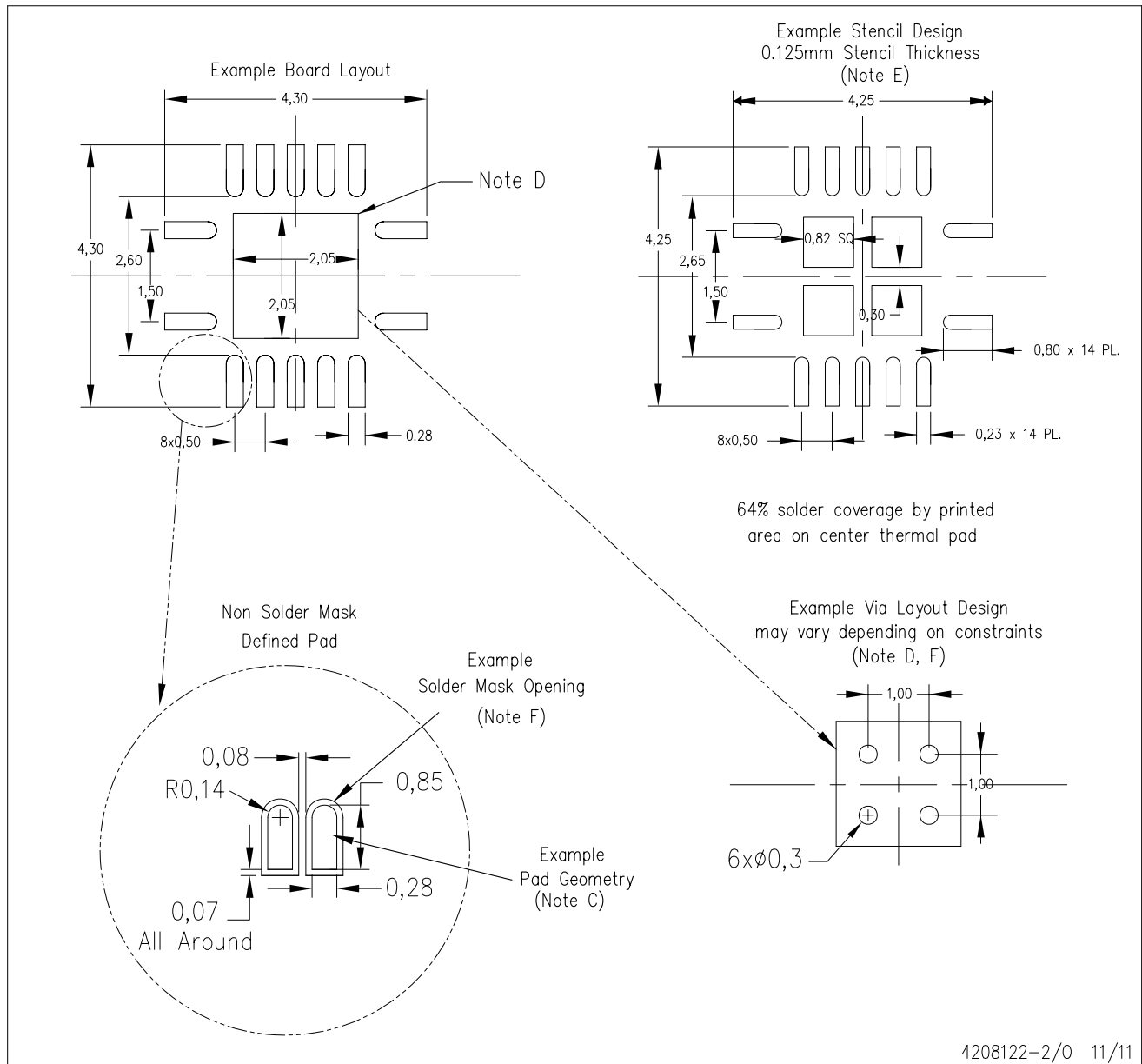

4208122-2/0 11/11

- NOTES:
- All linear dimensions are in millimeters.
 - This drawing is subject to change without notice.
 - Publication IPC-7351 is recommended for alternate designs.
 - This package is designed to be soldered to a thermal pad on the board. Refer to Application Note, Quad Flat-Pack QFN/SON PCB Attachment, Texas Instruments Literature No. SLUA271, and also the Product Data Sheets for specific thermal information, via requirements, and recommended board layout. These documents are available at www.ti.com <<http://www.ti.com>>.
 - Laser cutting apertures with trapezoidal walls and also rounding corners will offer better paste release. Customers should contact their board assembly site for stencil design recommendations. Refer to IPC 7525 for stencil design considerations.
 - Customers should contact their board fabrication site for minimum solder mask web tolerances between signal pads.

D (R-PDSO-G8)

PLASTIC SMALL OUTLINE



- NOTES:
- A. All linear dimensions are in millimeters.
 - B. This drawing is subject to change without notice.
 - C. Publication IPC-7351 is recommended for alternate designs.
 - D. Laser cutting apertures with trapezoidal walls and also rounding corners will offer better paste release. Customers should contact their board assembly site for stencil design recommendations. Refer to IPC-7525 for other stencil recommendations.
 - E. Customers should contact their board fabrication site for solder mask tolerances between and around signal pads.

IMPORTANT NOTICE

Texas Instruments Incorporated and its subsidiaries (TI) reserve the right to make corrections, enhancements, improvements and other changes to its semiconductor products and services per JESD46, latest issue, and to discontinue any product or service per JESD48, latest issue. Buyers should obtain the latest relevant information before placing orders and should verify that such information is current and complete. All semiconductor products (also referred to herein as "components") are sold subject to TI's terms and conditions of sale supplied at the time of order acknowledgment.

TI warrants performance of its components to the specifications applicable at the time of sale, in accordance with the warranty in TI's terms and conditions of sale of semiconductor products. Testing and other quality control techniques are used to the extent TI deems necessary to support this warranty. Except where mandated by applicable law, testing of all parameters of each component is not necessarily performed.

TI assumes no liability for applications assistance or the design of Buyers' products. Buyers are responsible for their products and applications using TI components. To minimize the risks associated with Buyers' products and applications, Buyers should provide adequate design and operating safeguards.

TI does not warrant or represent that any license, either express or implied, is granted under any patent right, copyright, mask work right, or other intellectual property right relating to any combination, machine, or process in which TI components or services are used. Information published by TI regarding third-party products or services does not constitute a license to use such products or services or a warranty or endorsement thereof. Use of such information may require a license from a third party under the patents or other intellectual property of the third party, or a license from TI under the patents or other intellectual property of TI.

Reproduction of significant portions of TI information in TI data books or data sheets is permissible only if reproduction is without alteration and is accompanied by all associated warranties, conditions, limitations, and notices. TI is not responsible or liable for such altered documentation. Information of third parties may be subject to additional restrictions.

Resale of TI components or services with statements different from or beyond the parameters stated by TI for that component or service voids all express and any implied warranties for the associated TI component or service and is an unfair and deceptive business practice. TI is not responsible or liable for any such statements.

Buyer acknowledges and agrees that it is solely responsible for compliance with all legal, regulatory and safety-related requirements concerning its products, and any use of TI components in its applications, notwithstanding any applications-related information or support that may be provided by TI. Buyer represents and agrees that it has all the necessary expertise to create and implement safeguards which anticipate dangerous consequences of failures, monitor failures and their consequences, lessen the likelihood of failures that might cause harm and take appropriate remedial actions. Buyer will fully indemnify TI and its representatives against any damages arising out of the use of any TI components in safety-critical applications.

In some cases, TI components may be promoted specifically to facilitate safety-related applications. With such components, TI's goal is to help enable customers to design and create their own end-product solutions that meet applicable functional safety standards and requirements. Nonetheless, such components are subject to these terms.

No TI components are authorized for use in FDA Class III (or similar life-critical medical equipment) unless authorized officers of the parties have executed a special agreement specifically governing such use.

Only those TI components which TI has specifically designated as military grade or "enhanced plastic" are designed and intended for use in military/aerospace applications or environments. Buyer acknowledges and agrees that any military or aerospace use of TI components which have **not** been so designated is solely at the Buyer's risk, and that Buyer is solely responsible for compliance with all legal and regulatory requirements in connection with such use.

TI has specifically designated certain components as meeting ISO/TS16949 requirements, mainly for automotive use. In any case of use of non-designated products, TI will not be responsible for any failure to meet ISO/TS16949.

Products

Audio	www.ti.com/audio
Amplifiers	amplifier.ti.com
Data Converters	dataconverter.ti.com
DLP® Products	www.dlp.com
DSP	dsp.ti.com
Clocks and Timers	www.ti.com/clocks
Interface	interface.ti.com
Logic	logic.ti.com
Power Mgmt	power.ti.com
Microcontrollers	microcontroller.ti.com
RFID	www.ti-rfid.com
OMAP Applications Processors	www.ti.com/omap
Wireless Connectivity	www.ti.com/wirelessconnectivity

Applications

Automotive and Transportation	www.ti.com/automotive
Communications and Telecom	www.ti.com/communications
Computers and Peripherals	www.ti.com/computers
Consumer Electronics	www.ti.com/consumer-apps
Energy and Lighting	www.ti.com/energy
Industrial	www.ti.com/industrial
Medical	www.ti.com/medical
Security	www.ti.com/security
Space, Avionics and Defense	www.ti.com/space-avionics-defense
Video and Imaging	www.ti.com/video

TI E2E Community

e2e.ti.com