

## LOW-NOISE, HIGH-SPEED, 450 mA CURRENT FEEDBACK AMPLIFIERS

### FEATURES

- **Low Noise**
  - 2.9 pA/√Hz Noninverting Current Noise
  - 10.8 pA/√Hz Inverting Current Noise
  - 2.2 nV/√Hz Voltage Noise
- **High Output Current, 450 mA**
- **High Speed**
  - 128 MHz, –3 dB BW( $R_L = 50 \Omega$ ,  $R_F = 470 \Omega$ )
  - 1550 V/ $\mu$ s Slew Rate ( $G = 2$ ,  $R_L = 50 \Omega$ )
- **Wide Output Swing**
  - 26 V<sub>PP</sub> Output Voltage,  $R_L = 50 \Omega$
- **Low Distortion**
  - –80 dBc (1 MHz, 2 V<sub>PP</sub>, G = 2)
- **Low Power Shutdown Mode (THS3125)**
  - 370- $\mu$ A Shutdown Supply Current
- **Standard SOIC, SOIC PowerPAD™, and TSSOP PowerPAD Package**

- **Line Drivers**
- **Motor Drivers**
- **Piezo Drivers**

### DESCRIPTION

The THS3122/5 are low-noise, high-speed current feedback amplifiers, with high output current drive. This makes them ideal for any application that requires low distortion over a wide frequency with heavy loads. The THS3122/5 can drive four serially terminated video lines while maintaining a differential gain error less than 0.03%.

The high output drive capability of the THS3122/5 enables the devices to drive 50- $\Omega$  loads with low distortion over a wide range of output voltages:

- 80 –dBc THD at 2 V<sub>PP</sub>
- 75 –dBc THD at 8 V<sub>PP</sub>

The THS3122/5 can operate from  $\pm 5$  V to  $\pm 15$  V supply voltages while drawing as little as 7.2 mA of supply current per channel. They offer a low power shutdown mode, reducing the supply current to only 370  $\mu$ A. The THS3122/5 are packaged in a standard SOIC, SOIC PowerPAD™, and TSSOP PowerPAD packages.

### APPLICATIONS

- **Video Distribution**
- **Instrumentation**

#### VOLTAGE NOISE AND CURRENT NOISE

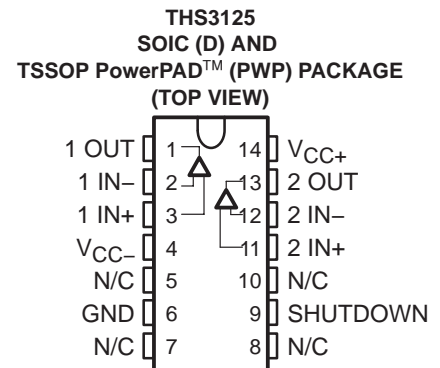
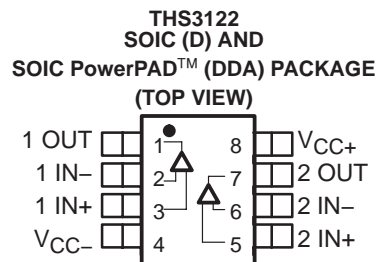
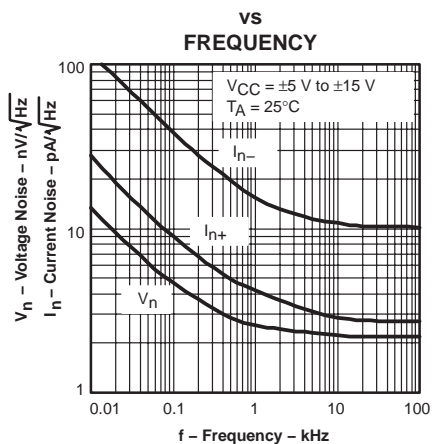

Please be aware that an important notice concerning availability, standard warranty, and use in critical applications of Texas Instruments semiconductor products and disclaimers thereto appears at the end of this data sheet.

PowerPAD is a trademark of Texas Instruments.

PRODUCTION DATA information is current as of publication date. Products conform to specifications per the terms of Texas Instruments standard warranty. Production processing does not necessarily include testing of all parameters.

**AVAILABLE OPTIONS**

T <sub>A</sub>	PACKAGED DEVICE				EVALUATION MODULES
	SOIC-8 (D)	SOIC-8 PowerPAD (DDA)	SOIC-14 (D)	TSSOP-14 (PWP)	
0°C to 70°C	THS3122CD	THS3122CDDA	THS3125CD	THS3125CPWP	THS3122EVM
-40°C to 85°C	THS3122ID	THS3122IDDA	THS3125ID	THS3125IPWP	THS3125EVM

**absolute maximum ratings over operating free-air temperature (unless otherwise noted)†**

Supply voltage, V <sub>CC+</sub> to V <sub>CC-</sub>	33 V
Input voltage	± V <sub>CC</sub>
Output current (see Note 1)	275 mA
Differential input voltage	± 4 V
Maximum junction temperature	150°C
Total power dissipation at (or below) 25°C free-air temperature	See Dissipation Ratings Table
Operating free-air temperature, T <sub>A</sub> : Commercial	0°C to 70°C
Industrial	-40°C to 85°C
Storage temperature, T <sub>stg</sub> : Commercial	-65°C to 125°C
Industrial	-65°C to 125°C
Lead temperature 1,6 mm (1/16 inch) from case for 10 seconds	300°C

† Stresses beyond those listed under “absolute maximum ratings” may cause permanent damage to the device. These are stress ratings only, and functional operation of the device at these or any other conditions beyond those indicated under “recommended operating conditions” is not implied. Exposure to absolute-maximum-rated conditions for extended periods may affect device reliability.

NOTE 1: The THS3122 and THS3125 may incorporate a PowerPAD™ on the underside of the chip. This acts as a heatsink and must be connected to a thermally dissipating plane for proper power dissipation. Failure to do so may result in exceeding the maximum junction temperature which could permanently damage the device. See TI Technical Brief SLMA002 for more information about utilizing the PowerPAD™ thermally enhanced package.

**DISSIPATION RATING TABLE**

PACKAGE	θ <sub>JA</sub>	T <sub>A</sub> = 25°C POWER RATING
D-8	95°C/W‡	1.32 W
DDA	67°C/W	1.87 W
D-14	66.6°C/W‡	1.88 W
PWP	37.5°C/W	3.3 W

‡ This data was taken using the JEDEC proposed high-K test PCB. For the JEDEC low-K test PCB, the θ<sub>JA</sub> is 168°C/W for the D-8 package and 122.3°C/W for the D-14 package.

**recommended operating conditions**

		MIN	NOM	MAX	UNIT
Supply voltage, V <sub>CC+</sub> to V <sub>CC-</sub>	Dual supply	±5		±15	V
	Single supply	10		30	
Operating free-air temperature, T <sub>A</sub>	C-suffix	0		70	°C
	I-suffix	-40		85	
Shutdown pin input levels, relative to the GND pin	High level (device shutdown)	2			V
	Low level (device active)			0.8	

electrical characteristics over recommended operating free-air temperature range,  $T_A = 25^\circ\text{C}$ ,  $V_{CC} = \pm 15\text{ V}$ ,  $R_F = 750\ \Omega$ ,  $R_L = 100\ \Omega$  (unless otherwise noted)

dynamic performance

PARAMETER		TEST CONDITIONS			MIN	TYP	MAX	UNIT
BW	Small-signal bandwidth (-3 dB)	$R_L = 50\ \Omega$	$R_F = 50\ \Omega$ , $G = 1$	$V_{CC} = \pm 5\text{ V}$		138	MHz	
				$V_{CC} = \pm 15\text{ V}$		160		
		$R_L = 50\ \Omega$	$R_F = 470\ \Omega$ , $G = 2$	$V_{CC} = \pm 5\text{ V}$		126		
				$V_{CC} = \pm 15\text{ V}$		128		
	Bandwidth (0.1 dB)		$R_F = 470\ \Omega$ , $G = 2$	$V_{CC} = \pm 5\text{ V}$		20		
				$V_{CC} = \pm 15\text{ V}$		30		
Full power bandwidth	$G = -1$		$V_{O(PP)} = 4\text{ V}$	$V_{CC} = \pm 5\text{ V}$		47	MHz	
			$V_{O(PP)} = 20\text{ V}$	$V_{CC} = \pm 15\text{ V}$		64		
SR	Slew rate (see Note 2), $G=8$	$G = 2$ $R_F = 680\ \Omega$	$V_O = 10\text{ V}_{PP}$	$V_{CC} = \pm 15\text{ V}$		1550	$\text{V}/\mu\text{s}$	
			$V_O = 5\text{ V}_{PP}$	$V_{CC} = \pm 5\text{ V}$		500		
				$V_{CC} = \pm 15\text{ V}$		1000		
$t_s$	Settling time to 0.1%	$G = -1$		$V_O = 2\text{ V}_{PP}$	$V_{CC} = \pm 5\text{ V}$		53	ns
				$V_O = 5\text{ V}_{PP}$	$V_{CC} = \pm 15\text{ V}$		64	

NOTE 2: Slew rate is defined from the 25% to the 75% output levels.

noise/distortion performance

PARAMETER		TEST CONDITIONS			MIN	TYP	MAX	UNIT
THD	Total harmonic distortion	$G = 2$ , $R_F = 470\ \Omega$ , $V_{CC} = \pm 15\text{ V}$ , $f = 1\text{ MHz}$	$V_{O(PP)} = 2\text{ V}$			-80	dBc	
			$V_{O(PP)} = 8\text{ V}$			-75		
		$G = 2$ , $R_F = 470\ \Omega$ , $V_{CC} = \pm 5\text{ V}$ , $f = 1\text{ MHz}$	$V_{O(PP)} = 2\text{ V}$			-77		
			$V_{O(PP)} = 5\text{ V}$			-76		
$V_n$	Input voltage noise	$V_{CC} = \pm 5\text{ V}, \pm 15\text{ V}$		$f = 10\text{ kHz}$		2.2	$\text{nV}/\sqrt{\text{Hz}}$	
$I_n$	Input current noise	Noninverting Input	$V_{CC} = \pm 5\text{ V}, \pm 15\text{ V}$		$f = 10\text{ kHz}$		2.9	$\text{pA}/\sqrt{\text{Hz}}$
		Inverting Input					10.8	
Crosstalk		$G = 2$ , $f = 1\text{ MHz}$ , $V_O = 2\text{ V}_{PP}$	$V_{CC} = \pm 5\text{ V}$			-67	dBc	
			$V_{CC} = \pm 15\text{ V}$			-67		
Differential gain error		$G = 2$ , $R_L = 150\ \Omega$ 40 IRE modulation	$V_{CC} = \pm 5\text{ V}$			0.01%		
			$V_{CC} = \pm 15\text{ V}$			0.01%		
Differential phase error		$\pm 100\text{ IRE Ramp}$ NTSC and PAL	$V_{CC} = \pm 5\text{ V}$			0.011°		
			$V_{CC} = \pm 15\text{ V}$			0.011°		

**electrical characteristics over recommended operating free-air temperature range,  $T_A = 25^\circ\text{C}$ ,  $V_{CC} = \pm 15\text{ V}$ ,  $R_F = 750\ \Omega$ ,  $R_L = 100\ \Omega$  (unless otherwise noted) (continued)**

**dc performance**

PARAMETER		TEST CONDITIONS		MIN	TYP	MAX	UNIT
$V_{IO}$	Input offset voltage	$V_{IC} = 0\text{ V}$ , $V_O = 0\text{ V}$ , $V_{CC} = \pm 5\text{ V}$ , $V_{CC} = \pm 15\text{ V}$	$T_A = 25^\circ\text{C}$	4.4	6	mV	
			$T_A = \text{full range}$		8		
	Channel offset voltage matching		$T_A = 25^\circ\text{C}$	0.4	2		
			$T_A = \text{full range}$		3		
Offset drift	$T_A = \text{full range}$		10		$\mu\text{V}/^\circ\text{C}$		
$I_{IB}$	IN– Input bias current	$V_{IC} = 0\text{ V}$ , $V_O = 0\text{ V}$ , $V_{CC} = \pm 5\text{ V}$ , $V_{CC} = \pm 15\text{ V}$	$T_A = 25^\circ\text{C}$	6	23	$\mu\text{A}$	
			$T_A = \text{full range}$		30		
	IN+ Input bias current		$T_A = 25^\circ\text{C}$	0.33	2		
			$T_A = \text{full range}$		3		
$I_{IO}$	Input offset current	$V_{IC} = 0\text{ V}$ , $V_O = 0\text{ V}$ , $V_{CC} = \pm 5\text{ V}$ , $V_{CC} = \pm 15\text{ V}$	$T_A = 25^\circ\text{C}$	5.4	22	$\mu\text{A}$	
			$T_A = \text{full range}$		30		
$Z_{OL}$	Open loop transimpedance	$V_{CC} = \pm 5\text{ V}$ , $V_{CC} = \pm 15\text{ V}$	$R_L = 1\text{ k}\Omega$		1		M $\Omega$

**input characteristics**

PARAMETER		TEST CONDITIONS		MIN	TYP	MAX	UNIT
$V_{ICR}$	Input common-mode voltage range	$V_{CC} = \pm 5\text{ V}$	$T_A = \text{full range}$	$\pm 2.5$	$\pm 2.7$	V	
		$V_{CC} = \pm 15\text{ V}$		$\pm 12.5$	$\pm 12.7$		
CMRR	Common-mode rejection ratio	$V_{CC} = \pm 5\text{ V}$ , $V_I = -2.5\text{ V to } 2.5\text{ V}$	$T_A = 25^\circ\text{C}$	58	62	dB	
			$T_A = \text{full range}$	56			
		$V_{CC} = \pm 15\text{ V}$ , $V_I = -12.5\text{ V to } 12.5\text{ V}$	$T_A = 25^\circ\text{C}$	63	67		
			$T_A = \text{full range}$	60			
$R_I$	Input resistance	IN+		1.5		M $\Omega$	
		IN–		15		$\Omega$	
$C_i$	Input capacitance			2		pF	

**output characteristics**

PARAMETER		TEST CONDITIONS		MIN	TYP	MAX	UNIT
$V_O$	Output voltage swing	$G = 4$ , $V_I = 1.06\text{ V}$ , $V_{CC} = \pm 5\text{ V}$	$R_L = 1\text{ k}\Omega$ , $T_A = 25^\circ\text{C}$		4.1		V
		$G = 4$ , $V_I = 1.025\text{ V}$ , $V_{CC} = \pm 5\text{ V}$	$R_L = 50\ \Omega$	$T_A = 25^\circ\text{C}$	3.8	4	V
				$T_A = \text{full range}$	3.7		
		$G = 4$ , $V_I = 3.6\text{ V}$ , $V_{CC} = \pm 15\text{ V}$	$R_L = 1\text{ k}\Omega$ , $T_A = 25^\circ\text{C}$		14.2		
		$G = 4$ , $V_I = 3.325\text{ V}$ , $V_{CC} = \pm 15\text{ V}$	$R_L = 50\ \Omega$	$T_A = 25^\circ\text{C}$	12	13.3	V
				$T_A = \text{full range}$	11.5		
$I_O$	Output current drive	$G = 4$ , $V_I = 1.025\text{ V}$ , $V_{CC} = \pm 5\text{ V}$	$R_L = 10\ \Omega$ , $T_A = 25^\circ\text{C}$	200	280	mA	
		$G = 4$ , $V_I = 3.325\text{ V}$ , $V_{CC} = \pm 15\text{ V}$	$R_L = 25\ \Omega$ , $T_A = 25^\circ\text{C}$	360	440	mA	
$r_o$	Output resistance	open loop	$T_A = 25^\circ\text{C}$		14	$\Omega$	

electrical characteristics over recommended operating free-air temperature range,  $T_A = 25^\circ\text{C}$ ,  $V_{CC} = \pm 15\text{ V}$ ,  $R_F = 750\ \Omega$ ,  $R_L = 100\ \Omega$  (unless otherwise noted) (continued)

**power supply**

PARAMETER		TEST CONDITIONS		MIN	TYP	MAX	UNIT
$I_{CC}$	Quiescent current (per channel)	$V_{CC} = \pm 5\text{ V}$	$T_A = 25^\circ\text{C}$	7.2	9	mA	
			$T_A = \text{full range}$	10			
		$V_{CC} = \pm 15\text{ V}$	$T_A = 25^\circ\text{C}$	8.4	10.5		
			$T_A = \text{full range}$	11.5			
PSRR	Power supply rejection ratio	$V_{CC} = \pm 5\text{ V} \pm 1\text{ V}$	$T_A = 25^\circ\text{C}$	53	60	dB	
			$T_A = \text{full range}$	50			
		$V_{CC} = \pm 15\text{ V} \pm 1\text{ V}$	$T_A = 25^\circ\text{C}$	68	73		
			$T_A = \text{full range}$	66			

**shutdown characteristics (THS3125 only)**

PARAMETER		TEST CONDITIONS		MIN	TYP	MAX	UNIT
$I_{CC}(\text{SHDN})$	Shutdown quiescent current (per channel)	$GND = 0\text{ V}$ $V_{CC} = \pm 5\text{ V to } \pm 15\text{ V}$	$V(\text{SHDN}) = 3.3\text{ V}$	370	500	$\mu\text{A}$	
$t_{\text{DIS}}$	Disable time (see Note 3)			200		ns	
$t_{\text{EN}}$	Enable time (see Note 3)			500		ns	
$I_{\text{IL}}(\text{SHDN})$	Shutdown pin low level leakage current		$V(\text{SHDN}) = 0\text{ V}$	18	25	$\mu\text{A}$	
$I_{\text{IH}}(\text{SHDN})$	Shutdown pin high level leakage current		$V(\text{SHDN}) = 3.3\text{ V}$	110	130	$\mu\text{A}$	

NOTE 3: Disable/enable time is defined as the time from when the shutdown signal is applied to the SHDN pin to when the supply current has reached half of its final value.

**TYPICAL CHARACTERISTICS**

**Table of Graphs**

			FIGURE
Small signal closed loop gain	vs Frequency		1 – 10
Small and large signal output	vs Frequency		11, 12
Harmonic distortion	vs Frequency		13, 14, 15
	vs Peak-to-peak output voltage		16, 17
$V_n, I_n$	Voltage noise and current noise	vs Frequency	18
CMRR	Common-mode rejection ratio	vs Frequency	19
	Crosstalk	vs Frequency	20
$Z_o$	Output impedance	vs Frequency	21
SR	Slew rate	vs Output voltage step	22
$V_{\text{IO}}$	Input offset voltage	vs Free-air temperature	23
		vs Common-mode input voltage	24
$I_B$	Input bias current	vs Free-air temperature	25
$V_O$	Output voltage	vs Load current	26
	Quiescent current	vs Free-air temperature	27
		vs Supply voltage	28
$I_{CC}$	Shutdown supply current	vs Free-air temperature	29
	Differential gain and phase error	vs $75\ \Omega$ serially terminated loads	30, 31
	Shutdown response		32
	Small signal pulse response		33, 34
	Large signal pulse response		35, 36

TYPICAL CHARACTERISTICS

SMALL SIGNAL CLOSED LOOP GAIN  
VS  
FREQUENCY

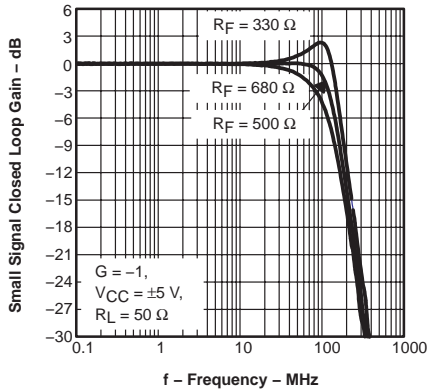

Figure 1

SMALL SIGNAL CLOSED LOOP GAIN  
VS  
FREQUENCY

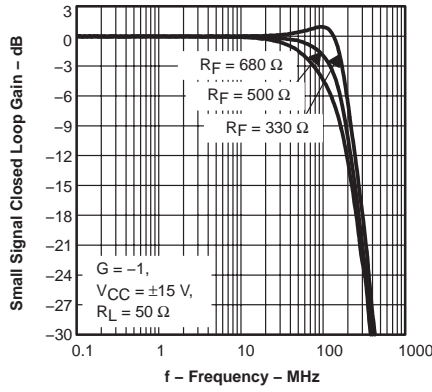

Figure 2

SMALL SIGNAL CLOSED LOOP GAIN  
VS  
FREQUENCY

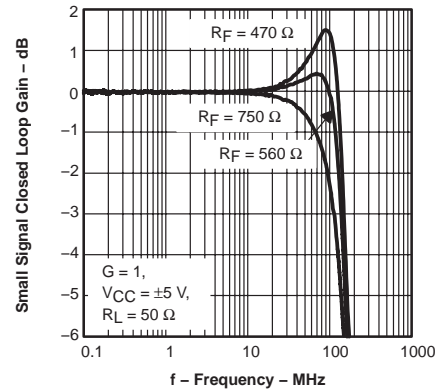

Figure 3

SMALL SIGNAL CLOSED LOOP GAIN  
VS  
FREQUENCY

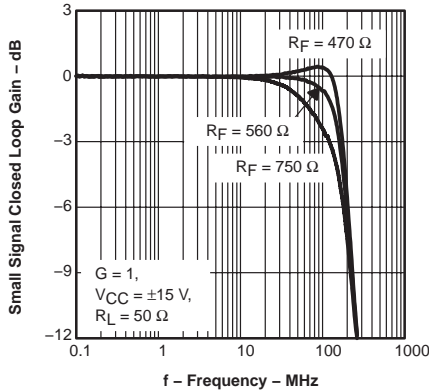

Figure 4

SMALL SIGNAL CLOSED LOOP GAIN  
VS  
FREQUENCY

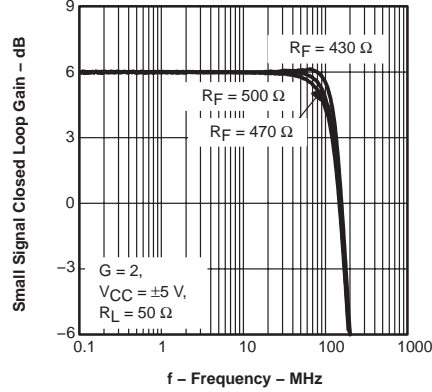

Figure 5

SMALL SIGNAL CLOSED LOOP GAIN  
VS  
FREQUENCY

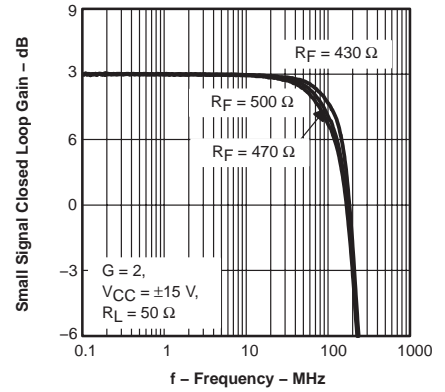

Figure 6

SMALL SIGNAL CLOSED LOOP GAIN  
VS  
FREQUENCY

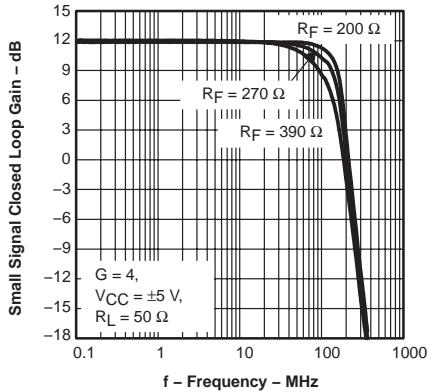

Figure 7

SMALL SIGNAL CLOSED LOOP GAIN  
VS  
FREQUENCY

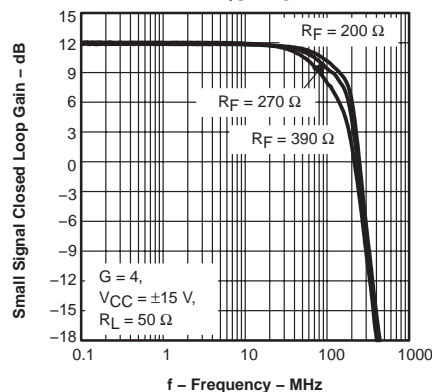

Figure 8

SMALL SIGNAL CLOSED LOOP GAIN  
VS  
FREQUENCY

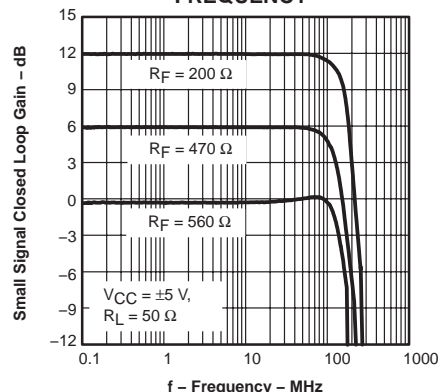

Figure 9

TYPICAL CHARACTERISTICS

SMALL SIGNAL CLOSED LOOP GAIN  
VS  
FREQUENCY

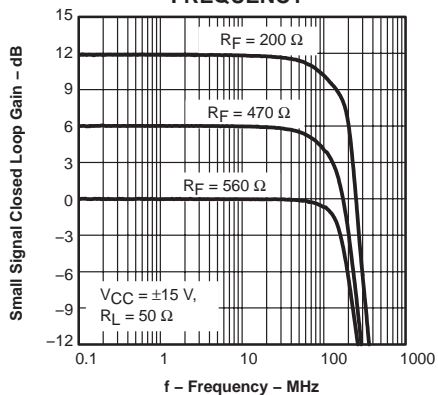

Figure 10

SMALL AND LARGE SIGNAL OUTPUT  
VS  
FREQUENCY

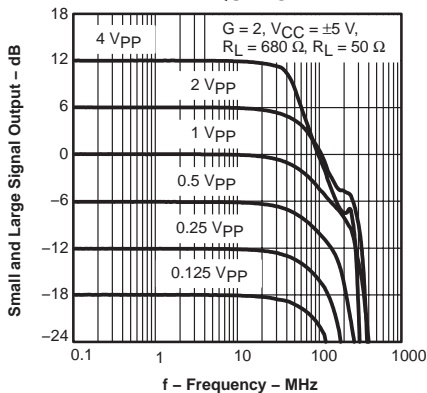

Figure 11

SMALL AND LARGE SIGNAL OUTPUT  
VS  
FREQUENCY

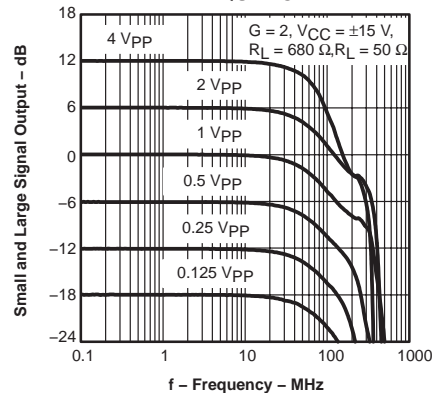

Figure 12

HARMONIC DISTORTION  
VS  
FREQUENCY

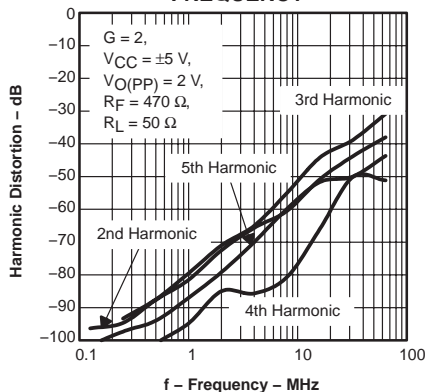

Figure 13

HARMONIC DISTORTION  
VS  
FREQUENCY

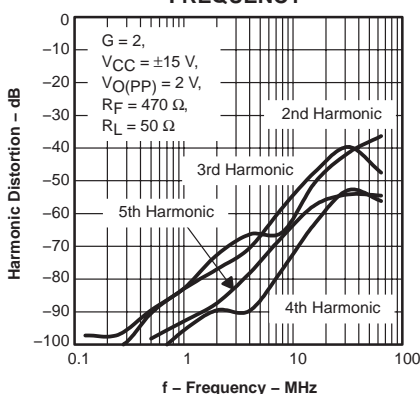

Figure 14

HARMONIC DISTORTION  
VS  
FREQUENCY

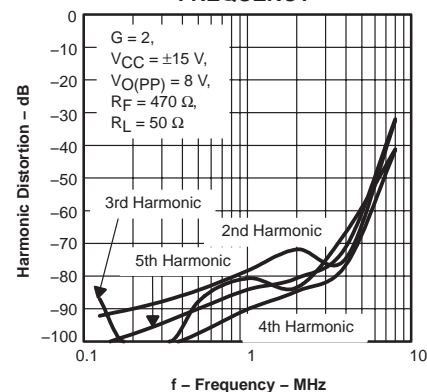

Figure 15

HARMONIC DISTORTION  
VS  
PEAK-TO-PEAK OUTPUT VOLTAGE

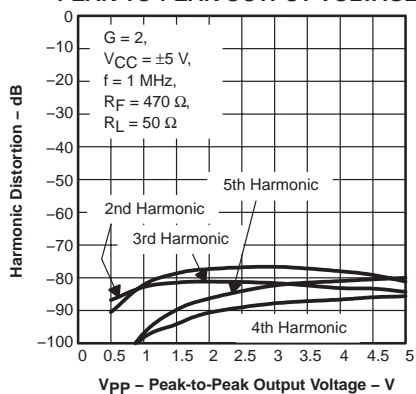

Figure 16

HARMONIC DISTORTION  
VS  
PEAK-TO-PEAK OUTPUT VOLTAGE

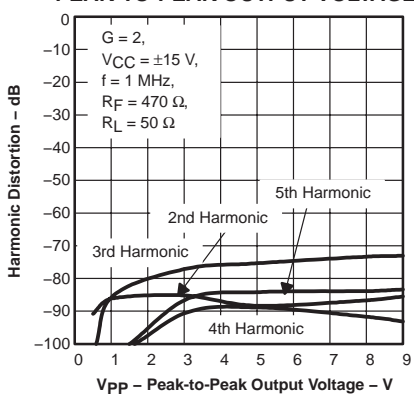

Figure 17

VOLTAGE NOISE AND CURRENT NOISE  
VS  
FREQUENCY

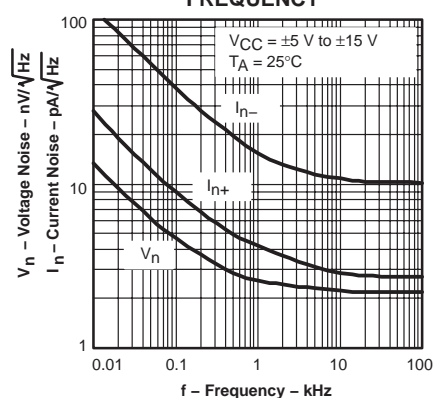

Figure 18

TYPICAL CHARACTERISTICS

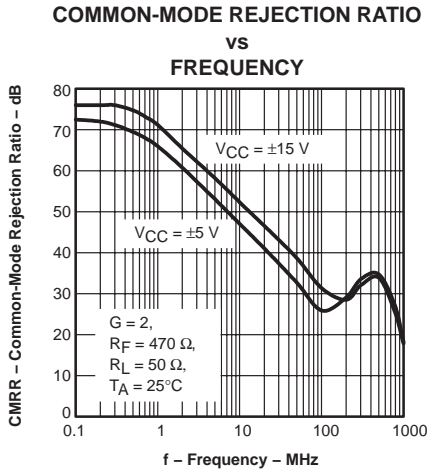

Figure 19

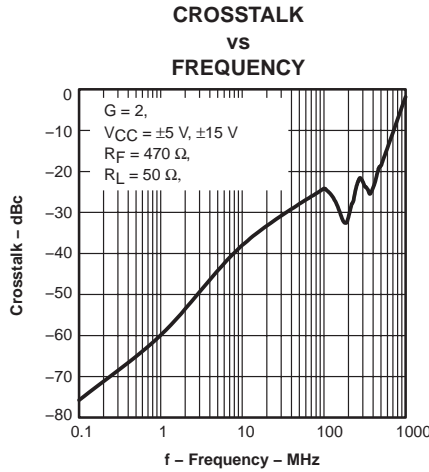

Figure 20

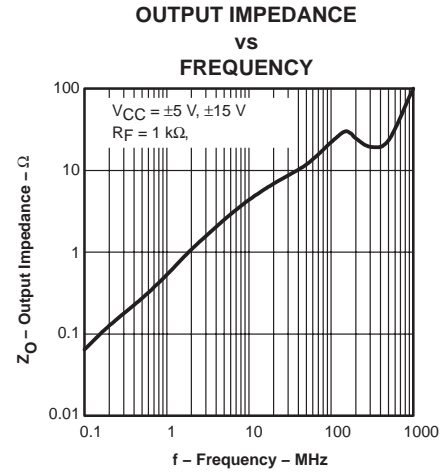

Figure 21

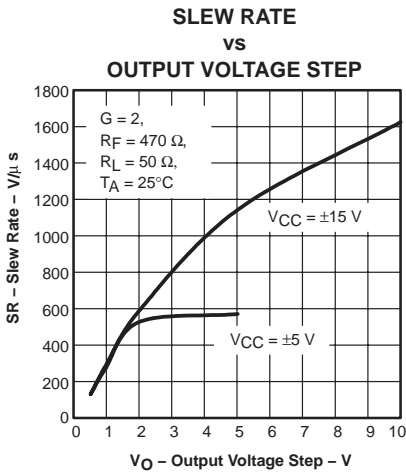

Figure 22

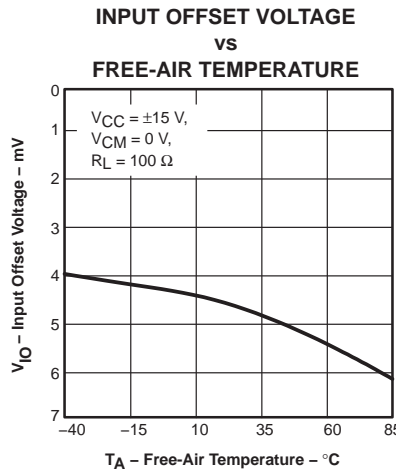

Figure 23

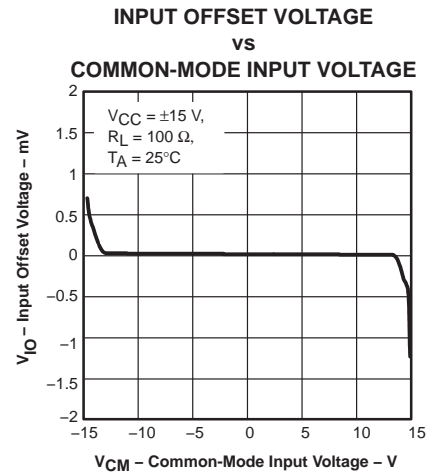

Figure 24

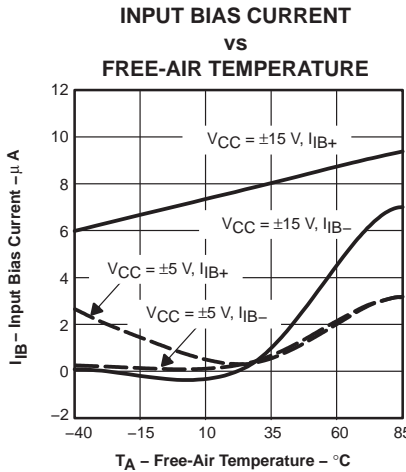

Figure 25

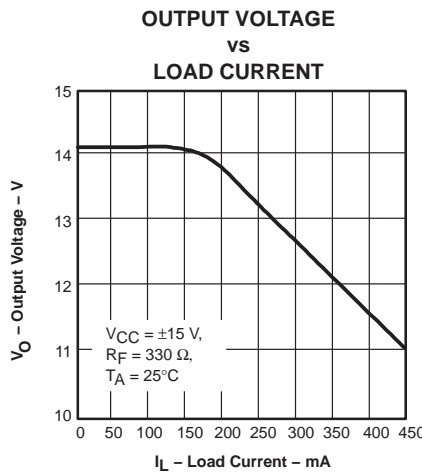

Figure 26

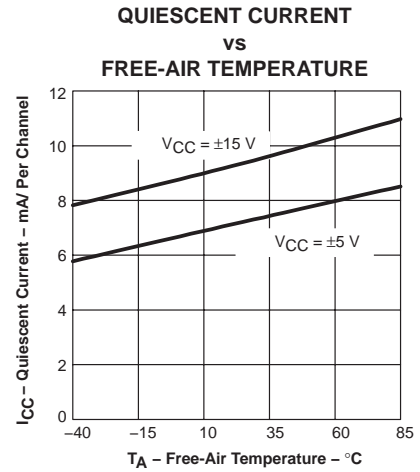

Figure 27



TYPICAL CHARACTERISTICS

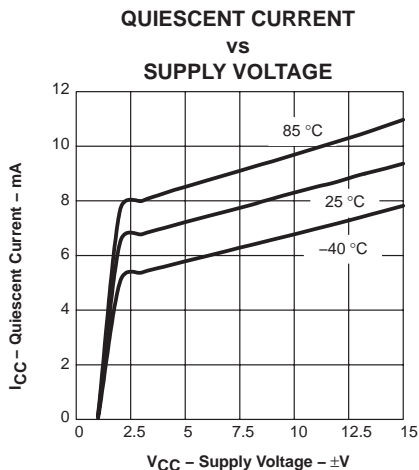

Figure 28

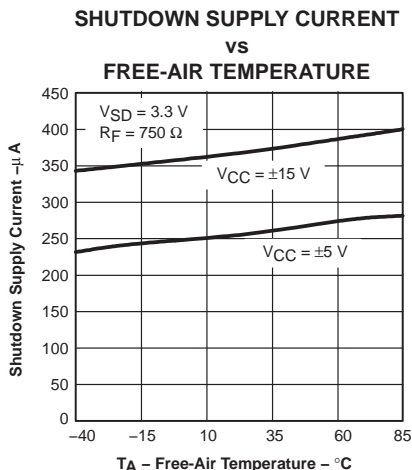

Figure 29

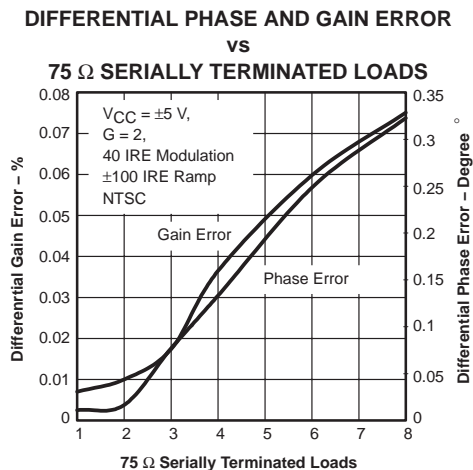

Figure 30

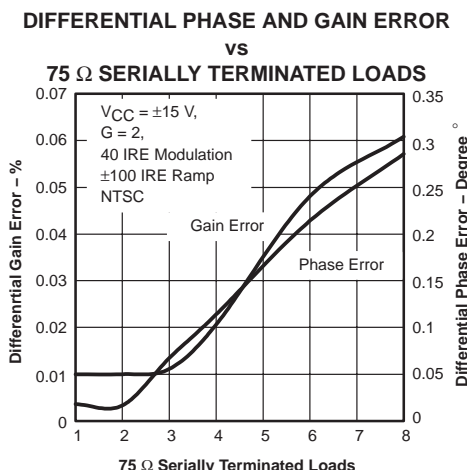

Figure 31

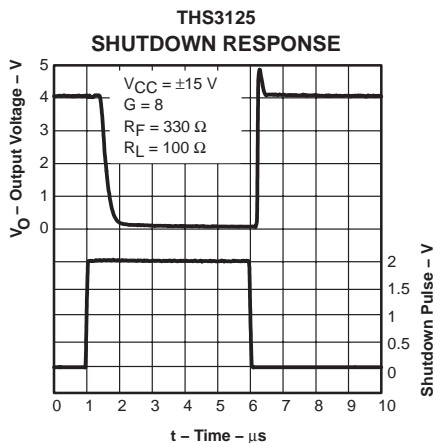

Figure 32

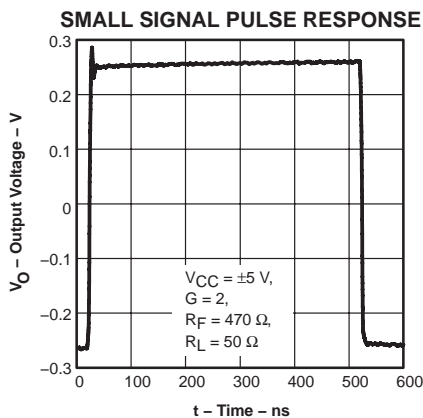

Figure 33

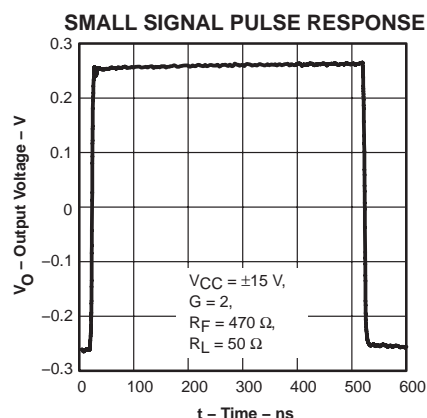

Figure 34

TYPICAL CHARACTERISTICS

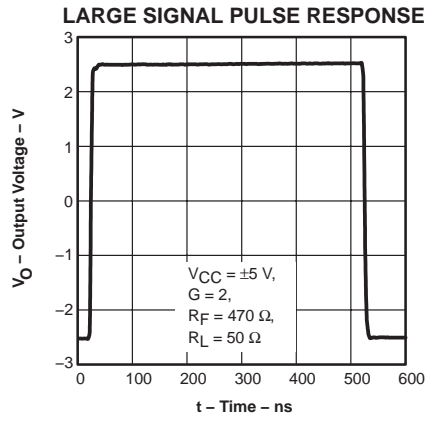

Figure 35

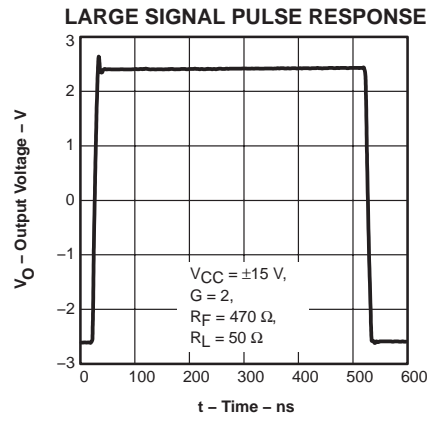

Figure 36

MECHANICAL DATA

D (R-PDSO-G\*\*)

PLASTIC SMALL-OUTLINE PACKAGE

14 PINS SHOWN

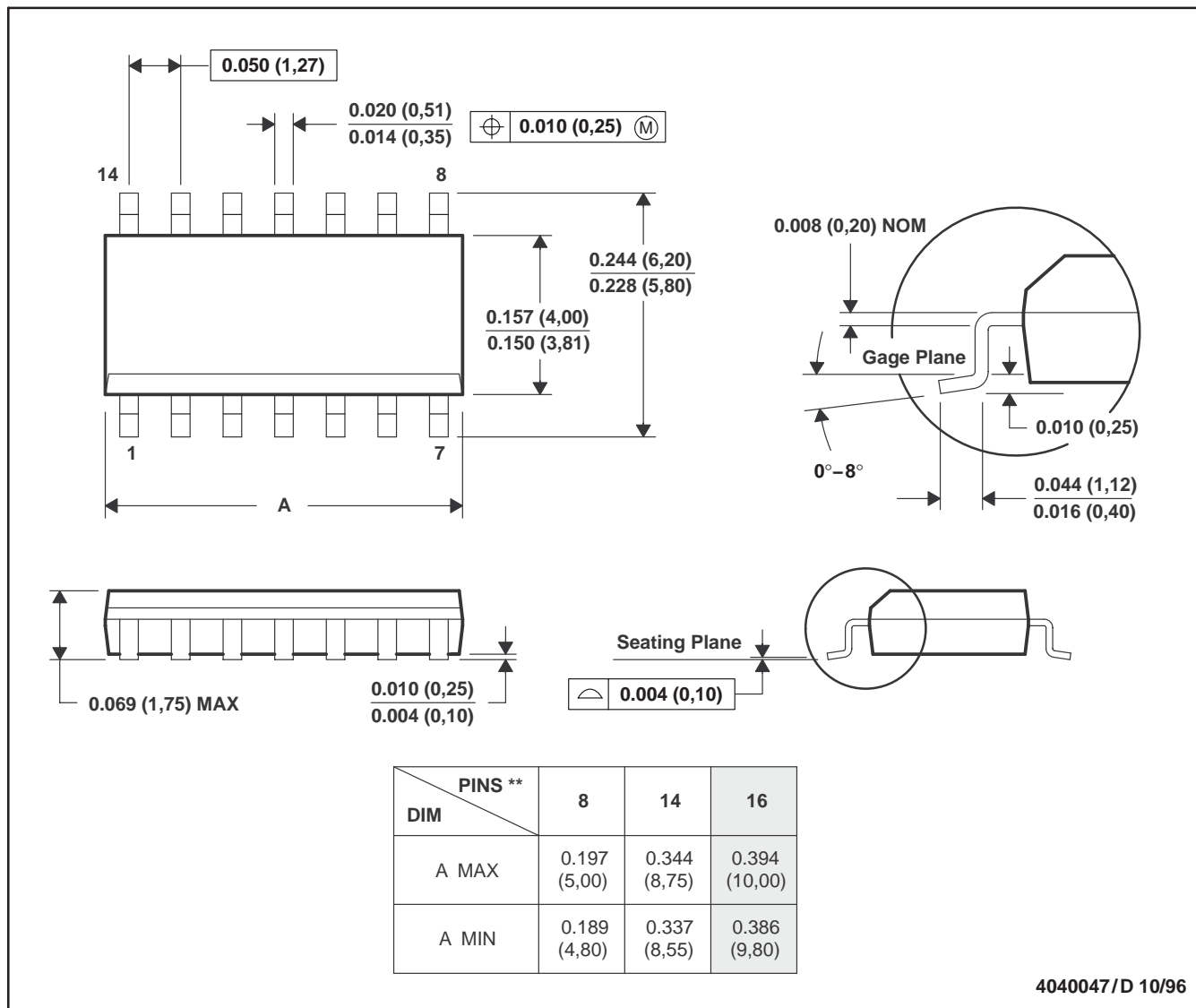

- NOTES: A. All linear dimensions are in inches (millimeters).  
 B. This drawing is subject to change without notice.  
 C. Body dimensions do not include mold flash or protrusion, not to exceed 0.006 (0,15).  
 D. Falls within JEDEC MS-012

MECHANICAL INFORMATION

DDA (S-PDSO-G8)

Power PAD™ PLASTIC SMALL-OUTLINE

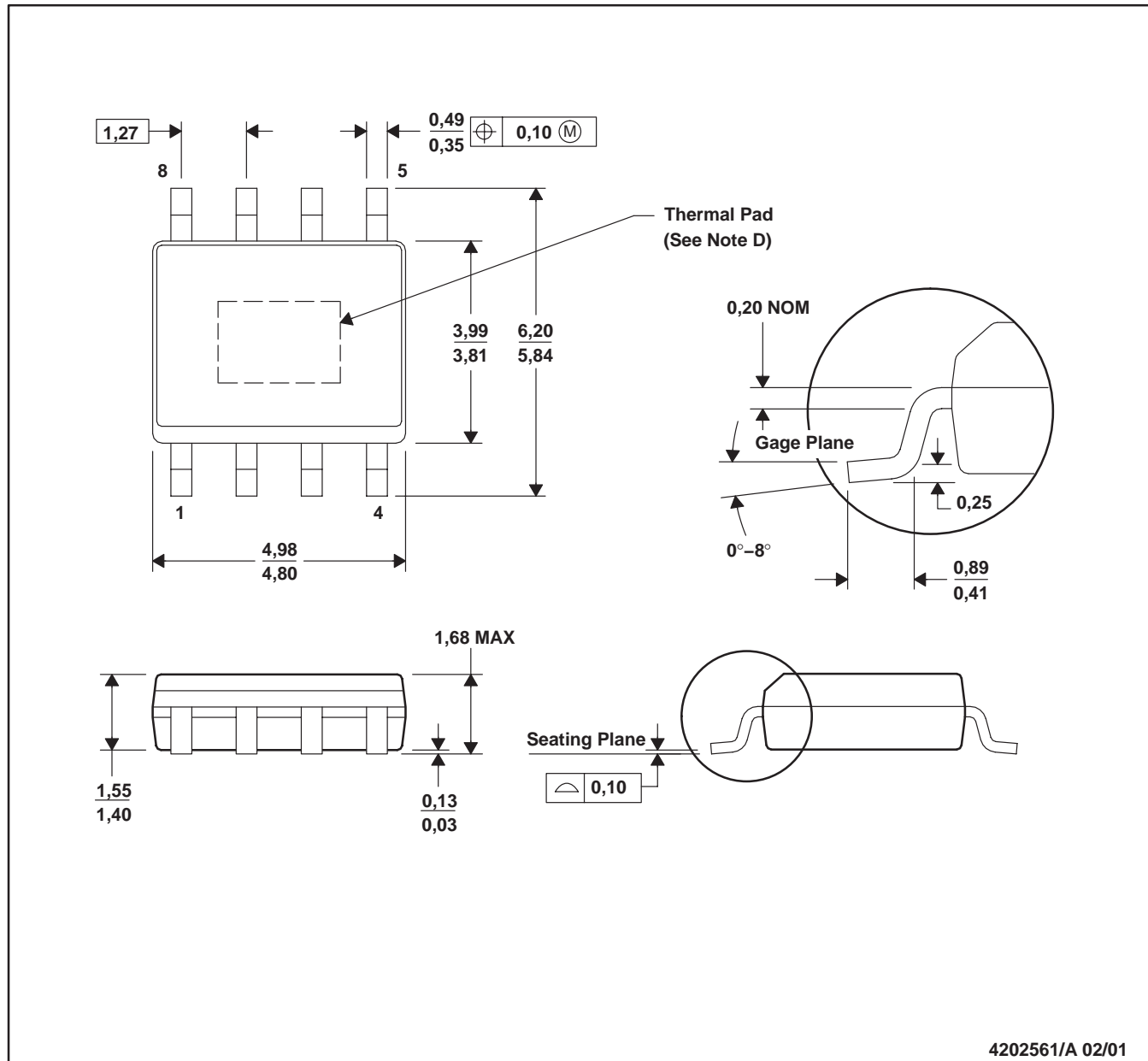

- NOTES: A. All linear dimensions are in millimeters.  
 B. This drawing is subject to change without notice.  
 C. Body dimensions do not include mold flash or protrusion not to exceed 0,15.  
 D. The package thermal performance may be enhanced by bonding the thermal pad to an external thermal plane. This pad is electrically and thermally connected to the backside of the die and possibly selected leads.

PowerPAD is a trademark of Texas Instruments.

MECHANICAL INFORMATION

PWP (R-PDSO-G\*\*)

PowerPAD™ PLASTIC SMALL-OUTLINE PACKAGE

20-PIN SHOWN

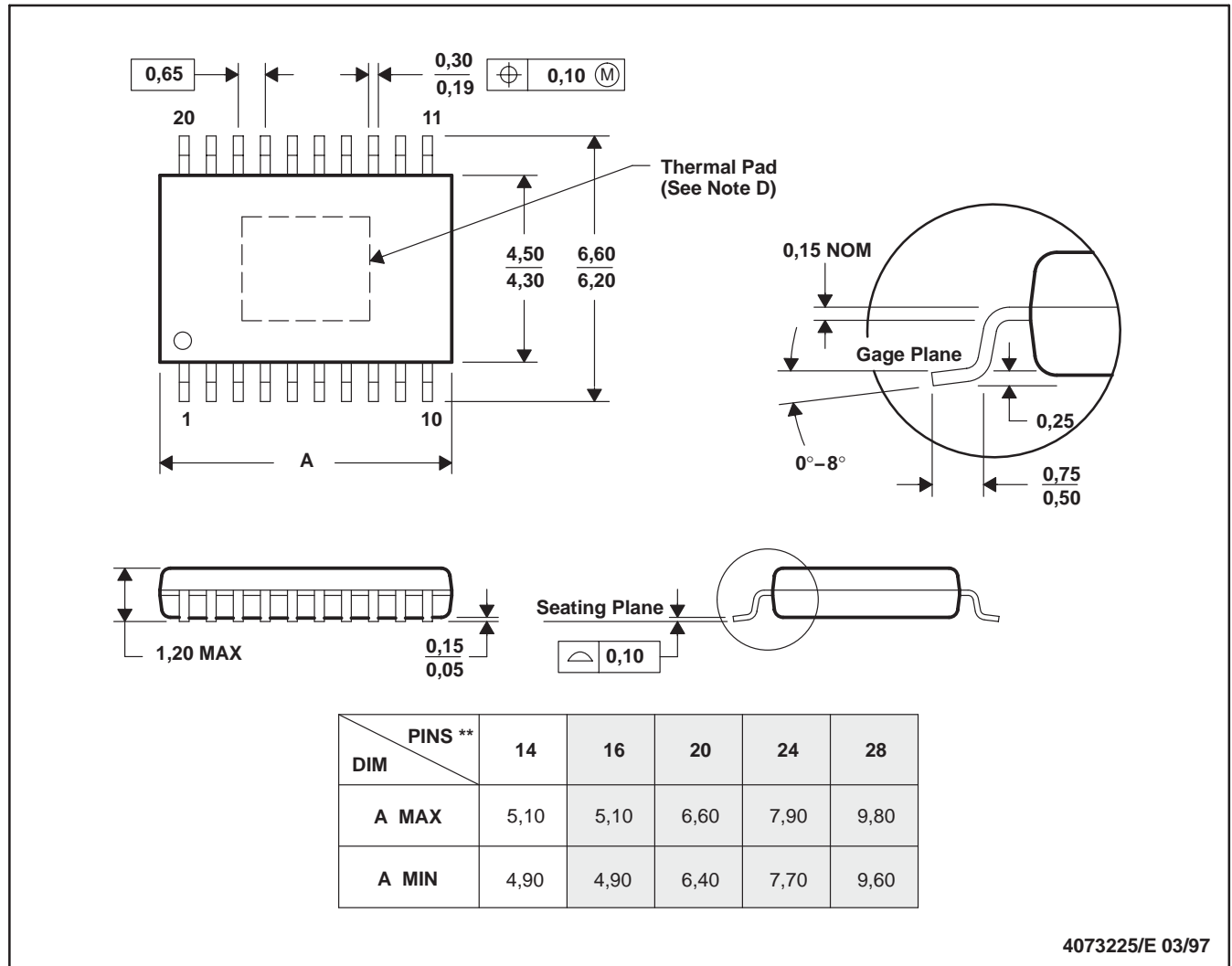

- NOTES: A. All linear dimensions are in millimeters.  
 B. This drawing is subject to change without notice.  
 C. Body dimensions do not include mold flash or protrusions.  
 D. The package thermal performance may be enhanced by bonding the thermal pad to an external thermal plane. This pad is electrically and thermally connected to the backside of the die and possibly selected leads.  
 E. Falls within JEDEC MO-153

PowerPAD is a trademark of Texas Instruments.

**PACKAGING INFORMATION**

Orderable Device	Status <sup>(1)</sup>	Package Type	Package Drawing	Pins	Package Qty	Eco Plan <sup>(2)</sup>	Lead/Ball Finish	MSL Peak Temp <sup>(3)</sup>
THS3122CD	ACTIVE	SOIC	D	8	75	Green (RoHS & no Sb/Br)	CU NIPDAU	Level-1-260C-UNLIM
THS3122CDDA	ACTIVE	SO Power PAD	DDA	8	75	TBD	Call TI	Level-1-235C-UNLIM
THS3122CDDAR	ACTIVE	SO Power PAD	DDA	8	2500	TBD	Call TI	Level-1-235C-UNLIM
THS3122CDG4	ACTIVE	SOIC	D	8	75	Green (RoHS & no Sb/Br)	CU NIPDAU	Level-1-260C-UNLIM
THS3122CDR	ACTIVE	SOIC	D	8	2500	Green (RoHS & no Sb/Br)	CU NIPDAU	Level-1-260C-UNLIM
THS3122CDRG4	ACTIVE	SOIC	D	8	2500	Green (RoHS & no Sb/Br)	CU NIPDAU	Level-1-260C-UNLIM
THS3122ID	ACTIVE	SOIC	D	8	75	Green (RoHS & no Sb/Br)	CU NIPDAU	Level-1-260C-UNLIM
THS3122IDDA	ACTIVE	SO Power PAD	DDA	8	75	TBD	Call TI	Level-1-235C-UNLIM
THS3122IDDAR	ACTIVE	SO Power PAD	DDA	8	2500	TBD	Call TI	Level-1-235C-UNLIM
THS3122IDR	ACTIVE	SOIC	D	8	2500	Green (RoHS & no Sb/Br)	CU NIPDAU	Level-1-260C-UNLIM
THS3122IDRG4	ACTIVE	SOIC	D	8	2500	Green (RoHS & no Sb/Br)	CU NIPDAU	Level-1-260C-UNLIM
THS3125CD	ACTIVE	SOIC	D	14	75	Green (RoHS & no Sb/Br)	CU NIPDAU	Level-1-260C-UNLIM
THS3125CDG4	ACTIVE	SOIC	D	14	75	Green (RoHS & no Sb/Br)	CU NIPDAU	Level-1-260C-UNLIM
THS3125CDR	ACTIVE	SOIC	D	14	2500	Green (RoHS & no Sb/Br)	CU NIPDAU	Level-1-260C-UNLIM
THS3125CDRG4	ACTIVE	SOIC	D	14	2500	Green (RoHS & no Sb/Br)	CU NIPDAU	Level-1-260C-UNLIM
THS3125CPWP	ACTIVE	HTSSOP	PWP	14	90	Green (RoHS & no Sb/Br)	CU NIPDAU	Level-2-260C-1 YEAR
THS3125CPWPG4	ACTIVE	HTSSOP	PWP	14	90	Green (RoHS & no Sb/Br)	CU NIPDAU	Level-2-260C-1 YEAR
THS3125CPWPR	ACTIVE	HTSSOP	PWP	14	2000	Green (RoHS & no Sb/Br)	CU NIPDAU	Level-2-260C-1 YEAR
THS3125CPWPRG4	ACTIVE	HTSSOP	PWP	14	2000	Green (RoHS & no Sb/Br)	CU NIPDAU	Level-2-260C-1 YEAR
THS3125ID	ACTIVE	SOIC	D	14	75	Green (RoHS & no Sb/Br)	CU NIPDAU	Level-1-260C-UNLIM
THS3125IDR	ACTIVE	SOIC	D	14	2500	Green (RoHS & no Sb/Br)	CU NIPDAU	Level-1-260C-UNLIM
THS3125IDRG4	ACTIVE	SOIC	D	14	2500	Green (RoHS & no Sb/Br)	CU NIPDAU	Level-1-260C-UNLIM
THS3125IPWP	ACTIVE	HTSSOP	PWP	14	90	Green (RoHS & no Sb/Br)	CU NIPDAU	Level-2-260C-1 YEAR

Orderable Device	Status <sup>(1)</sup>	Package Type	Package Drawing	Pins	Package Qty	Eco Plan <sup>(2)</sup>	Lead/Ball Finish	MSL Peak Temp <sup>(3)</sup>
THS3125IPWPG4	ACTIVE	HTSSOP	PWP	14	90	Green (RoHS & no Sb/Br)	CU NIPDAU	Level-2-260C-1 YEAR
THS3125IPWPR	ACTIVE	HTSSOP	PWP	14	2000	Green (RoHS & no Sb/Br)	CU NIPDAU	Level-2-260C-1 YEAR
THS3125IPWPRG4	ACTIVE	HTSSOP	PWP	14	2000	Green (RoHS & no Sb/Br)	CU NIPDAU	Level-2-260C-1 YEAR

<sup>(1)</sup> The marketing status values are defined as follows:

**ACTIVE:** Product device recommended for new designs.

**LIFEBUY:** TI has announced that the device will be discontinued, and a lifetime-buy period is in effect.

**NRND:** Not recommended for new designs. Device is in production to support existing customers, but TI does not recommend using this part in a new design.

**PREVIEW:** Device has been announced but is not in production. Samples may or may not be available.

**OBSOLETE:** TI has discontinued the production of the device.

<sup>(2)</sup> Eco Plan - The planned eco-friendly classification: Pb-Free (RoHS) or Green (RoHS & no Sb/Br) - please check <http://www.ti.com/productcontent> for the latest availability information and additional product content details.

**TBD:** The Pb-Free/Green conversion plan has not been defined.

**Pb-Free (RoHS):** TI's terms "Lead-Free" or "Pb-Free" mean semiconductor products that are compatible with the current RoHS requirements for all 6 substances, including the requirement that lead not exceed 0.1% by weight in homogeneous materials. Where designed to be soldered at high temperatures, TI Pb-Free products are suitable for use in specified lead-free processes.

**Green (RoHS & no Sb/Br):** TI defines "Green" to mean Pb-Free (RoHS compatible), and free of Bromine (Br) and Antimony (Sb) based flame retardants (Br or Sb do not exceed 0.1% by weight in homogeneous material)

<sup>(3)</sup> MSL, Peak Temp. -- The Moisture Sensitivity Level rating according to the JEDEC industry standard classifications, and peak solder temperature.

**Important Information and Disclaimer:** The information provided on this page represents TI's knowledge and belief as of the date that it is provided. TI bases its knowledge and belief on information provided by third parties, and makes no representation or warranty as to the accuracy of such information. Efforts are underway to better integrate information from third parties. TI has taken and continues to take reasonable steps to provide representative and accurate information but may not have conducted destructive testing or chemical analysis on incoming materials and chemicals. TI and TI suppliers consider certain information to be proprietary, and thus CAS numbers and other limited information may not be available for release.

In no event shall TI's liability arising out of such information exceed the total purchase price of the TI part(s) at issue in this document sold by TI to Customer on an annual basis.

PWP (R-PDSO-G\*\*) 20 PIN SHOWN

PowerPAD™ PLASTIC SMALL-OUTLINE PACKAGE

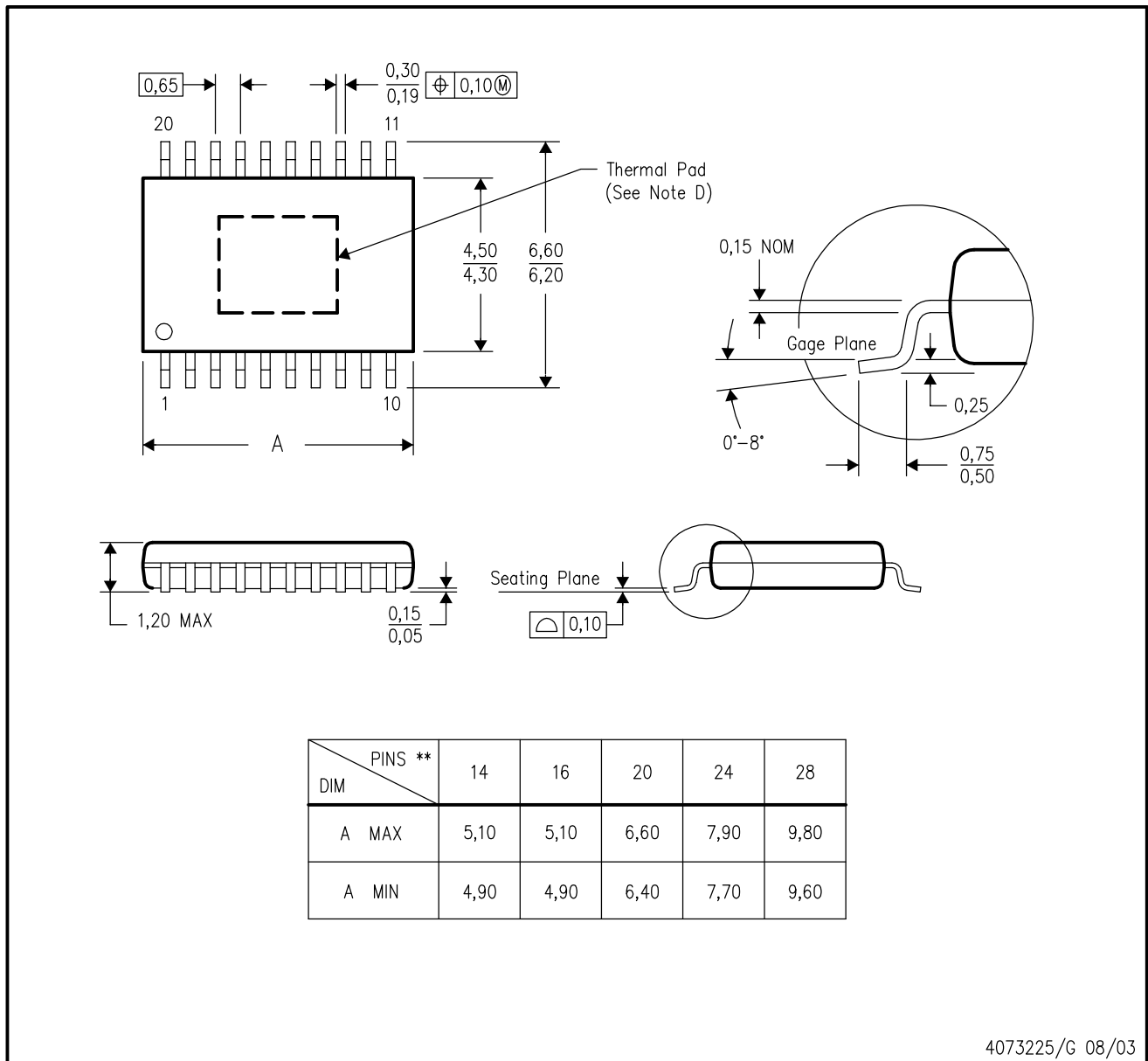

4073225/G 08/03

- NOTES:
- A. All linear dimensions are in millimeters.
  - B. This drawing is subject to change without notice.
  - C. Body dimensions do not include mold flash or protrusions.
  - D. This package is designed to be soldered to a thermal pad on the board. Refer to Technical Brief, PowerPad Thermally Enhanced Package, Texas Instruments Literature No. SLMA002 for information regarding recommended board layout. This document is available at [www.ti.com](http://www.ti.com) <<http://www.ti.com>>.
  - E. Falls within JEDEC MO-153

PowerPAD is a trademark of Texas Instruments.



DDA (R-PDSO-G8)

PowerPAD™ PLASTIC SMALL-OUTLINE PACKAGE

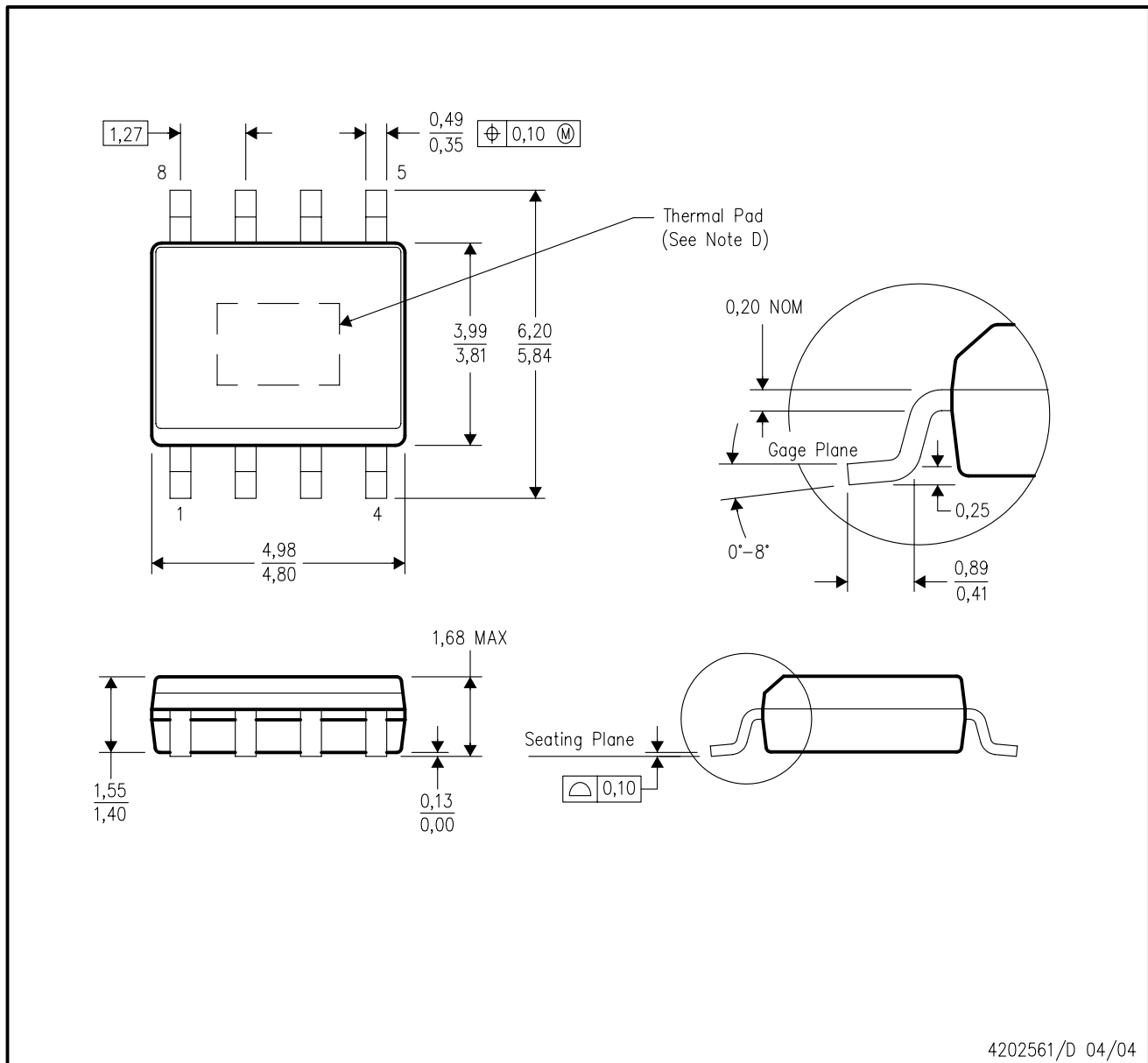

- NOTES:
- All linear dimensions are in millimeters.
  - This drawing is subject to change without notice.
  - Body dimensions do not include mold flash or protrusion not to exceed 0,15.
  - This package is designed to be soldered to a thermal pad on the board. Refer to Technical Brief, PowerPad Thermally Enhanced Package, Texas Instruments Literature No. SLMA002 for information regarding recommended board layout. This document is available at [www.ti.com](http://www.ti.com) <<http://www.ti.com>>.

PowerPAD is a trademark of Texas Instruments.





## IMPORTANT NOTICE

Texas Instruments Incorporated and its subsidiaries (TI) reserve the right to make corrections, modifications, enhancements, improvements, and other changes to its products and services at any time and to discontinue any product or service without notice. Customers should obtain the latest relevant information before placing orders and should verify that such information is current and complete. All products are sold subject to TI's terms and conditions of sale supplied at the time of order acknowledgment.

TI warrants performance of its hardware products to the specifications applicable at the time of sale in accordance with TI's standard warranty. Testing and other quality control techniques are used to the extent TI deems necessary to support this warranty. Except where mandated by government requirements, testing of all parameters of each product is not necessarily performed.

TI assumes no liability for applications assistance or customer product design. Customers are responsible for their products and applications using TI components. To minimize the risks associated with customer products and applications, customers should provide adequate design and operating safeguards.

TI does not warrant or represent that any license, either express or implied, is granted under any TI patent right, copyright, mask work right, or other TI intellectual property right relating to any combination, machine, or process in which TI products or services are used. Information published by TI regarding third-party products or services does not constitute a license from TI to use such products or services or a warranty or endorsement thereof. Use of such information may require a license from a third party under the patents or other intellectual property of the third party, or a license from TI under the patents or other intellectual property of TI.

Reproduction of information in TI data books or data sheets is permissible only if reproduction is without alteration and is accompanied by all associated warranties, conditions, limitations, and notices. Reproduction of this information with alteration is an unfair and deceptive business practice. TI is not responsible or liable for such altered documentation.

Resale of TI products or services with statements different from or beyond the parameters stated by TI for that product or service voids all express and any implied warranties for the associated TI product or service and is an unfair and deceptive business practice. TI is not responsible or liable for any such statements.

Following are URLs where you can obtain information on other Texas Instruments products and application solutions:

<b>Products</b>		<b>Applications</b>	
Amplifiers	<a href="http://amplifier.ti.com">amplifier.ti.com</a>	Audio	<a href="http://www.ti.com/audio">www.ti.com/audio</a>
Data Converters	<a href="http://dataconverter.ti.com">dataconverter.ti.com</a>	Automotive	<a href="http://www.ti.com/automotive">www.ti.com/automotive</a>
DSP	<a href="http://dsp.ti.com">dsp.ti.com</a>	Broadband	<a href="http://www.ti.com/broadband">www.ti.com/broadband</a>
Interface	<a href="http://interface.ti.com">interface.ti.com</a>	Digital Control	<a href="http://www.ti.com/digitalcontrol">www.ti.com/digitalcontrol</a>
Logic	<a href="http://logic.ti.com">logic.ti.com</a>	Military	<a href="http://www.ti.com/military">www.ti.com/military</a>
Power Mgmt	<a href="http://power.ti.com">power.ti.com</a>	Optical Networking	<a href="http://www.ti.com/opticalnetwork">www.ti.com/opticalnetwork</a>
Microcontrollers	<a href="http://microcontroller.ti.com">microcontroller.ti.com</a>	Security	<a href="http://www.ti.com/security">www.ti.com/security</a>
		Telephony	<a href="http://www.ti.com/telephony">www.ti.com/telephony</a>
		Video & Imaging	<a href="http://www.ti.com/video">www.ti.com/video</a>
		Wireless	<a href="http://www.ti.com/wireless">www.ti.com/wireless</a>

Mailing Address: Texas Instruments  
Post Office Box 655303 Dallas, Texas 75265